

**APPENDICES**

มหาวิทยาลัยเชียงใหม่  
Chiang Mai University

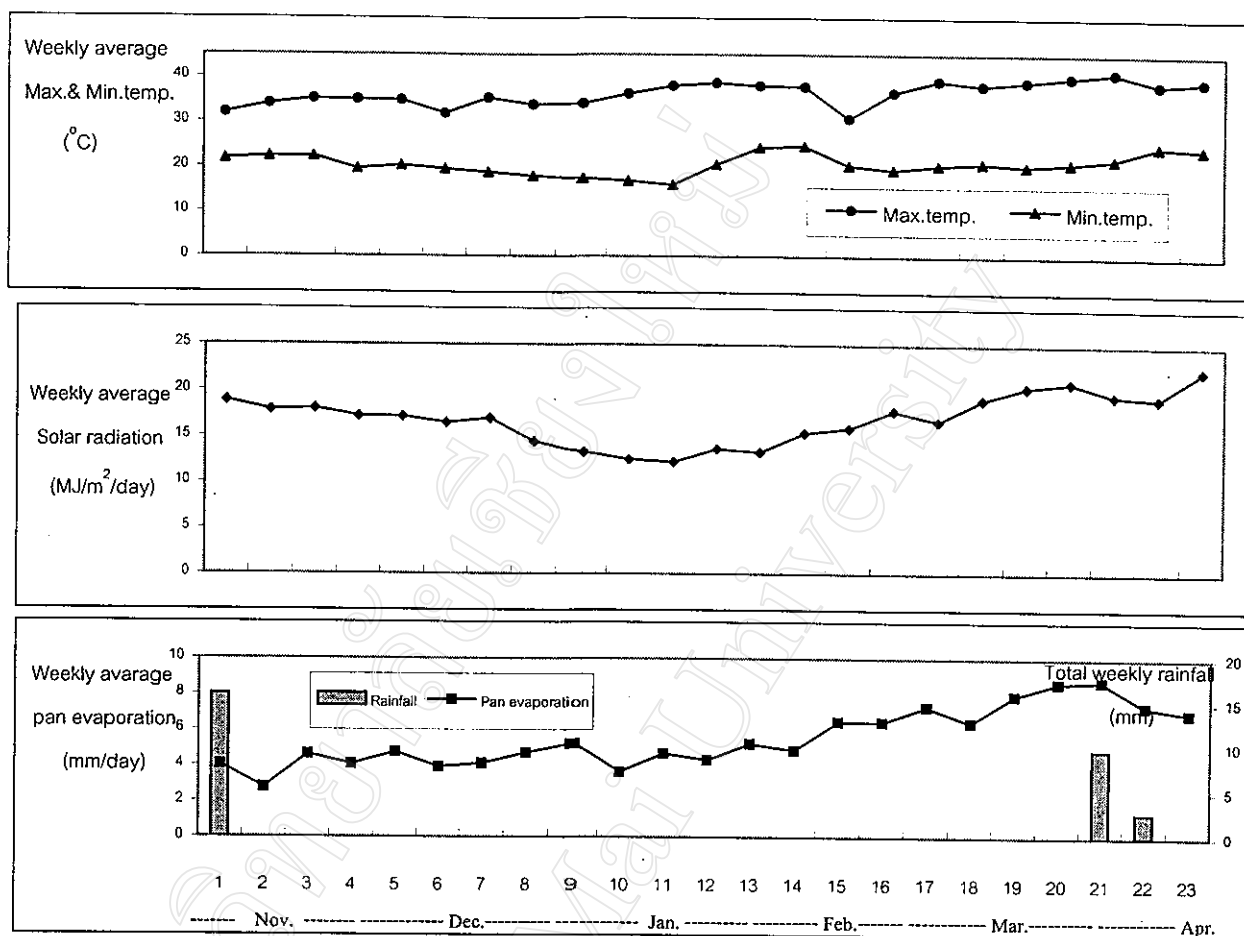

Appendix 1 Weekly values of weathering data (December 1997 - March 1998) during the field experiment

Appendix 2 The chemical and physical soil properties at 0-30 cm of soil depth in the rainfed lowland field at LARTC, Lampang.

Field plot	pH	Organic matter (%)	Avail. P (ppm)	Exch. K (ppm)	Texture	Sand (%)	Silt (%)	Clay (%)
Block A3	5.5	1.11	131	96	Sandy clay loam	64	25	33
Block A4	5.4	0.97	144	77	Sandy clay loam	62	27	29

Note Average data shown in the table were sampling 10 replications /block and used to be composited sample before analysis.

Appendix 3 Analysis of variance of photosynthetic rate, transpiration rate and stomatal resistance of nine barley genotypes under three water treatments.

<i>Photosynthetic rate at 3-4 leaf stage</i>			<i>Coefficient of variation = 13.85 %</i>		
<i>Source of variation</i>	<i>df</i>	<i>Sum of Squares</i>	<i>Mean Square</i>	<i>F value</i>	<i>Prob.</i>
Water treatments	2	34.495	17.247	10.828	0.024
Error (a)	4	6.372	1.593		
Barley genotypes	8	86.78	10.847	8.875	0.000
W x V interaction	16	177.168	11.073	9.06	0.000
Error (b)	48	58.667	1.222		
Total	80	366.594			

<i>Photosynthetic rate at 1st tiller stage</i>			<i>Coefficient of variation = 14.08%</i>		
<i>Source of variation</i>	<i>df</i>	<i>Sum of Squares</i>	<i>Mean Square</i>	<i>F value</i>	<i>Prob.</i>
Water treatments	2	253.482	126.741	21.328	0.001
Error (a)	4	35.655	5.942		
Barley genotypes	8	78.233	9.779	2.707	0.011
W x V interaction	16	293.454	18.341	5.077	0.000
Error (b)	48	260.100	3.613		
Total	80	922.543			

<i>Photosynthetic rate at booting stage</i>			<i>Coefficient of variation = 15.07 %</i>		
<i>Source of variation</i>	<i>df</i>	<i>Sum of Squares</i>	<i>Mean Square</i>	<i>F value</i>	<i>Prob.</i>
Water treatments	2	156.957	78.479	42.914	0.000
Error (a)	4	10.972	1.829		
Barley genotypes	8	152.739	19.092	6.867	0.000
W x V interaction	16	212.556	13.285	4.778	0.000
Error (b)	48	200.172	2.780		
Total	80	739.077			

<i>Photosynthetic rate at heading stage</i>			<i>Coefficient of variation = 14.64 %</i>		
<i>Source of variation</i>	<i>df</i>	<i>Sum of Squares</i>	<i>Mean Square</i>	<i>F value</i>	<i>Prob.</i>
Water treatments	2	97.884	48.942	7.723	0.022
Error (a)	4	38.021	6.337		
Barley genotypes	8	145.540	18.193	7.452	0.000
W x V interaction	16	98.668	6.167	2.526	0.004
Error (b)	48	175.782	2.441		
Total	80	564.059			

Appendix 3 (continued) Analysis of variance of photosynthetic rate, transpiration rate and stomatal resistance of nine barley genotypes under three water treatments.

<i>Transpiration rate at 3-4 leaf stage</i>					
<i>Coefficient of variation = 15.38 %</i>					
<i>Source of variation</i>	<i>df</i>	<i>Sum of Squares</i>	<i>Mean Square</i>	<i>F value</i>	<i>Prob.</i>
Water treatments	2	1.557	0.779	3.673	0.124
Error (a)	4	0.848	0.212		
Barley genotypes	8	2.644	0.33	2.35	0.032
W x V interaction	16	5.284	0.33	2.349	0.012
Error (b)	48	6.75	0.141		
Total	80	17.383			

<i>Transpiration rate at 1st tiller stage</i>					
<i>Coefficient of variation = 15.88 %</i>					
<i>Source of variation</i>	<i>df</i>	<i>Sum of Squares</i>	<i>Mean Square</i>	<i>F value</i>	<i>Prob.</i>
Water treatments	2	41.748	20.874	33.731	0.000
Error (a)	4	3.713	0.619		
Barley genotypes	8	14.751	1.844	6.304	0.000
W x V interaction	16	19.903	1.244	4.253	0.000
Error (b)	48	21.059	0.292		
Total	80	102.156			

<i>Transpiration rate at booting stage</i>					
<i>Coefficient of variation = 15.69 %</i>					
<i>Source of variation</i>	<i>df</i>	<i>Sum of Squares</i>	<i>Mean Square</i>	<i>F value</i>	<i>Prob.</i>
Water treatments	2	14.810	7.405	32.314	0.001
Error (a)	4	1.375	0.229		
Barley genotypes	8	2.823	0.353	2.996	0.006
W x V interaction	16	8.139	0.509	4.320	0.000
Error (b)	48	8.479	0.118		
Total	80	35.695			

<i>Transpiration rate at heading stage</i>					
<i>Coefficient of variation = 12.55 %</i>					
<i>Source of variation</i>	<i>df</i>	<i>Sum of Squares</i>	<i>Mean Square</i>	<i>F value</i>	<i>Prob.</i>
Water treatments	2	3.247	1.624	4.617	0.051
Error (a)	4	2.110	0.352		
Barley genotypes	8	15.277	1.910	16.129	0.000
W x V interaction	16	16.382	1.024	8.648	0.000
Error (b)	48	8.524	0.118		
Total	80	47.840			

Appendix 3 (continued) Analysis of variance of photosynthetic rate, transpiration rate and stomatal resistance of nine barley genotypes under three water treatments.

<i>Stomatal resistance at 3-4 leaf stage</i>			<i>Coefficient of variation = 14.75 %</i>		
<i>Source of variation</i>	<i>df</i>	<i>Sum of Squares</i>	<i>Mean Square</i>	<i>F value</i>	<i>Prob.</i>
Water treatments	2	8281.699	4140.85	15.414	0.013
Error (a)	4	1074.601	268.65		
Barley genotypes	8	21943.975	2742.997	8.2923	0.000
W x V interaction	16	12022.309	751.394	2.2715	0.014
Error (b)	48	15877.773	330.787		
Total	80	59716.346			

<i>Stomatal resistance at 1st tiller stage</i>			<i>Coefficient of variation = 14.64 %</i>		
<i>Source of variation</i>	<i>df</i>	<i>Sum of Squares</i>	<i>Mean Square</i>	<i>F value</i>	<i>Prob.</i>
Water treatments	2	1160.568	580.284	10.493	0.011
Error (a)	4	331.820	55.303		
Barley genotypes	8	905.902	113.238	3.627	0.001
W x V interaction	16	1949.603	121.850	3.903	0.000
Error (b)	48	2247.720	31.218		
Total	80	6655.040			

<i>Stomatal resistance at booting stage</i>			<i>Coefficient of variation = 15.34 %</i>		
<i>Source of variation</i>	<i>df</i>	<i>Sum of Squares</i>	<i>Mean Square</i>	<i>F value</i>	<i>Prob.</i>
Water treatments	2	280.541	140.271	13.036	0.006
Error (a)	4	64.560	10.760		
Barley genotypes	8	165.554	20.694	3.047	0.005
W x V interaction	16	325.108	20.319	2.992	0.001
Error (b)	48	489.034	6.792		
Total	80	1328.829			

<i>Stomatal resistance at heading stage</i>			<i>Coefficient of variation = 15.98 %</i>		
<i>Source of variation</i>	<i>df</i>	<i>Sum of Squares</i>	<i>Mean Square</i>	<i>F value</i>	<i>Prob.</i>
Water treatments	2	977.670	488.835	257.483	0.000
Error (a)	4	11.391	1.899		
Barley genotypes	8	723.854	90.482	19.413	0.000
W x V interaction	16	625.487	39.093	8.388	0.000
Error (b)	48	335.578	4.661		
Total	80	2675.524			

Appendix 4 Analysis of variance of total dry matter at maturity, grain yield and the yield components of nine barley genotypes under three water treatments in paddy field.

*Total dry matter at maturity*

<i>Source of variation</i>	<i>df</i>	<i>Sum of Squares</i>	<i>Mean Square</i>	<i>F value</i>	<i>Prob.</i>
Water treatments	2	100311.003	50155.502	24.1465	0.006
Error (a)	4	8308.52	2077.13		
Barley genotypes	8	69646.334	8705.792	8.7615	0.000
W x V interaction	16	21877.42	1367.339	1.3761	0.194
Error (b)	48	47694.595	993.637		
Total	80	252548.739			

*Coefficient of variation = 19.46 %*

*Spikes /m<sup>2</sup>*

<i>Source of variation</i>	<i>df</i>	<i>Sum of Squares</i>	<i>Mean Square</i>	<i>F value</i>	<i>Prob.</i>
Water treatments	2	196313.580	98156.790	33.083	0.003
Error (a)	4	11867.901	2966.975		
Barley genotypes	8	118326.543	14790.818	8.765	0.000
W x V interaction	16	82547.531	5159.221	3.057	0.001
Error (b)	48	81003.704	1687.577		
Total	80	534837.654			

*Coefficient of variation = 13.89 %*

*Seeds / spike*

<i>Source of variation</i>	<i>df</i>	<i>Sum of Squares</i>	<i>Mean Square</i>	<i>F value</i>	<i>Prob.</i>
Water treatments	2	422.988	211.494	4.238	0.103
Error (a)	4	199.605	49.901		
Barley genotypes	8	2129.062	266.133	28.280	0.000
W x V interaction	16	779.679	48.730	5.178	0.000
Error (b)	48	451.704	9.410		
Total	80	3983.728			

*Coefficient of variation = 15.02 %*

Appendix 4 (continued) Analysis of variance of total dry matter, grain yield and the yield components of nine barley genotypes under three water treatments in paddy field.

*The 1,000 grain weight*

<i>Source of variation</i>	<i>df</i>	<i>Sum of Squares</i>	<i>Mean Square</i>	<i>F value</i>	<i>Prob.</i>
Water treatments	2	819.843	459.921	13.264	0.001
Error (a)	4	138.697	34.674		
Barley genotypes	8	2611.980	326.498	15.285	0.000
W x V interaction	16	1041.537	65.096	3.048	0.001
Error (b)	48	1025.284	21.360		
Total	80	5732.243			

*Coefficient of variation = 11.10 %*

*Grain yield*

<i>Source of variation</i>	<i>df</i>	<i>Sum of Squares</i>	<i>Mean Square</i>	<i>F value</i>	<i>Prob.</i>
Water treatments	2	313121.830	156560.915	91.225	0.001
Error (a)	4	6864.799	1716.200		
Barley genotypes	8	65101.467	8137.683	4.077	0.001
W x V interaction	16	92725.001	5795.313	2.903	0.010
Error (b)	48	95814.422	1996.134		
Total	80	552768.163			

*Coefficient of variation = 25.86 %*

**Appendix 5** Path-coefficient analysis which indicated direct and indirect pathways of some influence of predictor variables; plant height, total dry matter at maturity, spikes/m<sup>2</sup> and seeds/spike on response variable as grain yield of barley genotypes under different water treatments (n= 81).  
( Multiple regression in MSTAT program was used by Abbreviated Doolittle Method).

Variables	Minimum	Maximum	Sum	Mean	Uncorrected sum of square
Plant height	50.40	91.20	5804.30	71.66	425786.76
Spikes/m <sup>2</sup>	120.00	460.00	23950.00	295.68	7616350.00
Seeds/spike	10.00	45.00	1654.00	20.42	37758.00
Total dry matter	61.65	297.30	13122.85	162.01	2378588.00
Grain yield	48.80	400.10	13996.85	172.80	2971432.28

**Correlation matrix ( r )**

Traits	Plant height	Spikes/m <sup>2</sup>	Seeds/spike	Total dry matter	Remark
Plant height	1				Determinant of matrix is 0.581042
Spikes/m <sup>2</sup>	0.195	1			
Seeds/spike	0.134	0.203	1		
Total dry matter	0.398	0.325	0.466	1	
Grain yield	0.484	0.563	0.52	0.637	

Trait	Regression coefficient	Standard Error	Standard partial regr. coeff. (b')	Std. error of partial coefficient	Student T value	Probability
Plant height	1.9632	0.5503	0.2622	0.0735	3.568	0.001
Spikes/m <sup>2</sup>	0.3688	0.0725	0.3628	0.0713	5.088	0.000
Seeds/spike	3.2786	0.8970	0.2783	0.0762	3.655	0.000
Total dry matter	4.2230	0.1245	0.2855	0.0841	3.393	0.001
Intercept =	-212.297	Coefficient of Determination (R-square) = 0.658				
Multiple R = 0.64	Adjusted R-square = 0.811		Std. error of estimation = 49.881			

**Analysis of variance table**

Source of data	df	Sum of square	Mean square	F value	Significant value
Regression	4	363671.282	90917.82	36.54	0.000
Residual	76	189096.881	2488.117		
Total	80	552768.163			



Appendix 5 (continued) Path-coefficient analysis which indicated direct and indirect of some influence of variables as grain yield of barley genotypes under different water treatments (n= 81).

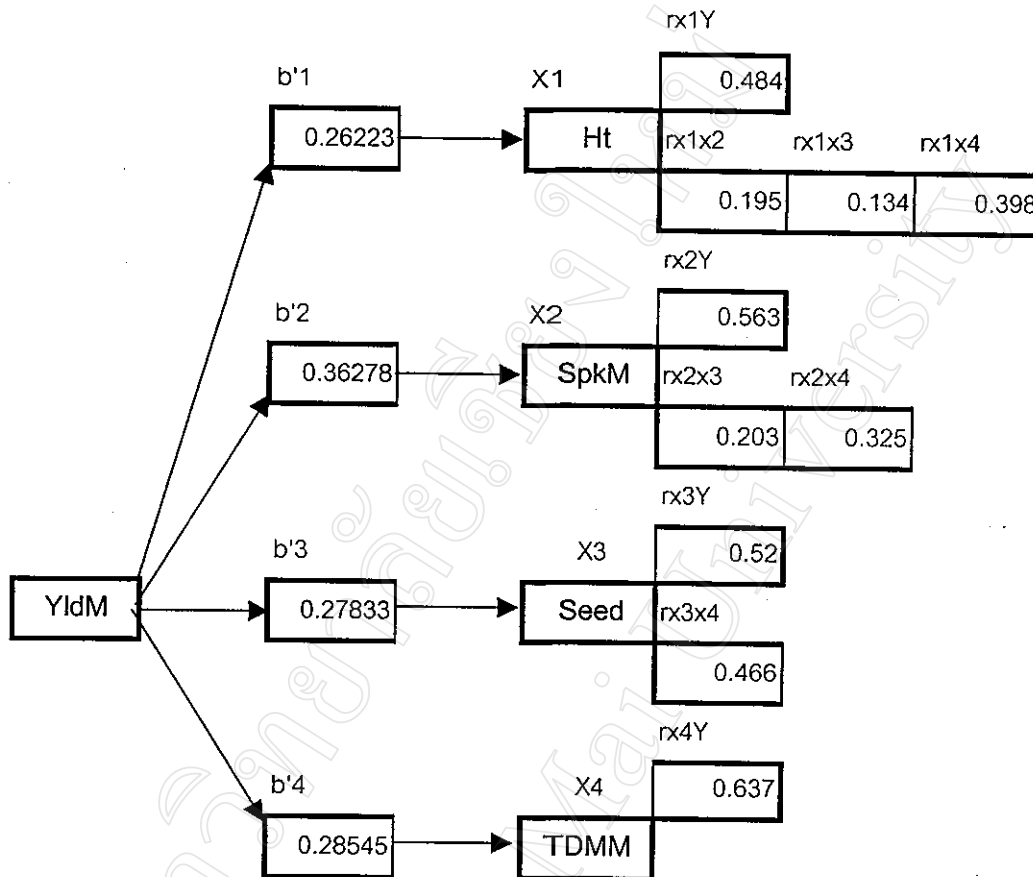

So that; 1) The influence of X1 on Y is...

- 1.1) Direct effect from X1 =  $b'1 = 0.26223$
  - 1.2) Indirect effect which passed to X2 =  $(b'2)(rx1x2) = 0.070742$
  - 1.3) Indirect effect which passed to X3 =  $(b'3)(rx1x3) = 0.037296$
  - 1.4) Indirect effect which passed to X4 =  $(b'4)(rx1x4) = 0.113609$
- All effects of X1 =  $rx1Y = 0.484$

2) The influence of X2 on Y is...

- 2.1) Direct effect from X2 =  $b'2 = 0.36278$
  - 2.2) Indirect effect which passed to X1 =  $(b'1)(rx1x2) = 0.051135$
  - 2.3) Indirect effect which passed to X3 =  $(b'3)(rx2x3) = 0.056501$
  - 2.4) Indirect effect which passed to X4 =  $(b'4)(rx2x4) = 0.092771$
- All effects of X2 =  $rx2Y = 0.563$

Appendix 5 (continued) Path-coefficient analysis which indicated direct and indirect of some influence of variables as grain yield of barley genotypes under different water treatments (n= 81).

3) The influence of X3 on Y is...

3.1) Direct effect from X3 = $b'3$ =	0.27833
3.2) Indirect effect which passed to X1 = $(b'1)(r_{1x3})$ =	0.035139
3.3) Indirect effect which passed to X2 = $(b'2)(r_{2x3})$ =	0.073644
3.4) Indirect effect which passed to X4 = $(b'4)(r_{3x4})$ =	0.13302
All effects of X3 = $r_{3Y}$ =	0.52

4) The influence of X4 on Y is...

4.1) Direct effect from X1 = $b'4$ =	0.28545
4.2) Indirect effect which passed to X1 = $(b'1)(r_{1x4})$ =	0.104368
4.3) Indirect effect which passed to X2 = $(b'2)(r_{2x4})$ =	0.117904
4.4) Indirect effect which passed to X3 = $(b'3)(r_{3x4})$ =	0.129702
All effects of X4 = $r_{4Y}$ =	0.637

Note :

YldM or Y= Grain yield/m<sup>2</sup>; Ht or X1 = Plant height; SpkM or X2 = Spikes /m<sup>2</sup>;

Seed or X3 = Seeds /spike and TDMM or X4 = Total dry matter (g /m<sup>2</sup>).

For  $b'1$ ;  $b'2$ ;  $b'3$ ; and  $b'4$  were the standard partial of regression coefficient data.

and  $r_{X1Y}$ ;  $r_{X2Y}$ ;  $r_{X3Y}$ ; and  $r_{X4Y}$  were the correlation matrix data.

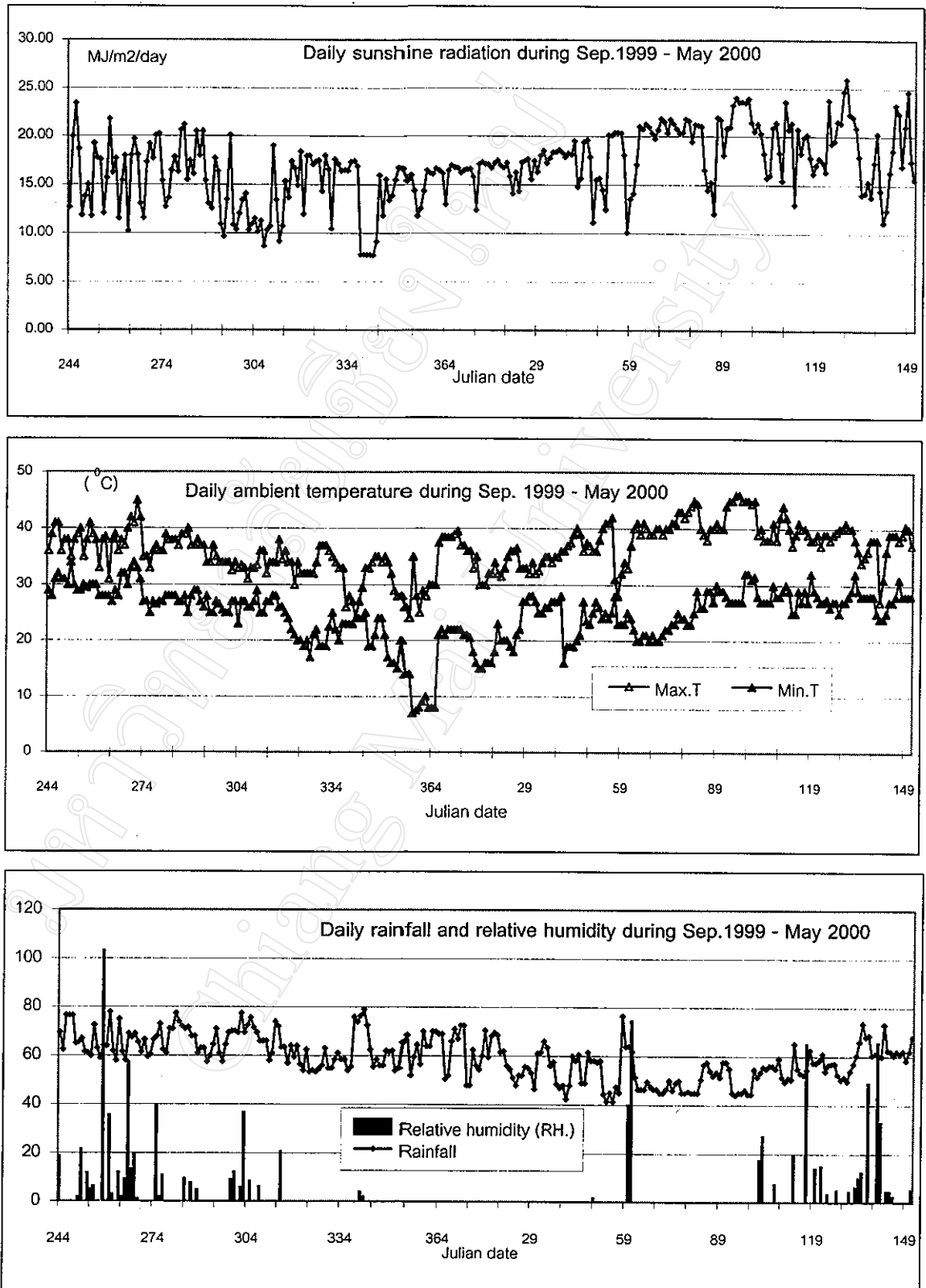

Appendix 6 Weekly values of weathering data from September 1999 - May 2000 during the pot experiment.

Appendix 7 Analysis of variance of the 1,000 seed weight, the percent of germination within 3 days; the percent of protein content in seeds of barley genotypes under different water treatments in pot experiment.

*The 1,000 grain weight* (Coefficient of variation = 4.82 %)

Source of variation	df	Sum of Squares	Mean Square	F value	Prob.
Water treatments	2	10.461	5.230	0.334	
Error (a)	9	140.843	15.649		
Barley genotypes	2	230.181	115.090	26.323	0.000
W x V interaction	4	19.486	4.872	1.114	0.381
Error (b)	18	78.700	4.372		
Total	35	479.670			

*The percent of seed germination* (Coefficient of variation = 7.80 %)

Source of variation	df	Sum of Squares	Mean Square	F value	Prob.
Water treatments	2	4456.167	2228.083	104.170	0.000
Error (a)	9	192.500	21.389		
Barley genotypes	2	952.667	476.333	16.779	0.000
W x V interaction	4	1771.667	427.917	15.073	0.000
Error (b)	18	511.000	28.389		
Total	35	7824.000			

*The percent of seed protein content* (Coefficient of variation = 0.25 %)

Source of variation	df	Sum of Squares	Mean Square	F value	Prob.
Water treatments	2	16.951	8.476	1607.025	0.000
Error (a)	9	0.047	0.005		
Barley genotypes	2	63.402	31.701	26747.500	0.000
W x V interaction	4	61.744	15.436	13024.103	0.000
Error (b)	18	0.021	0.001		
Total	35	142.166			

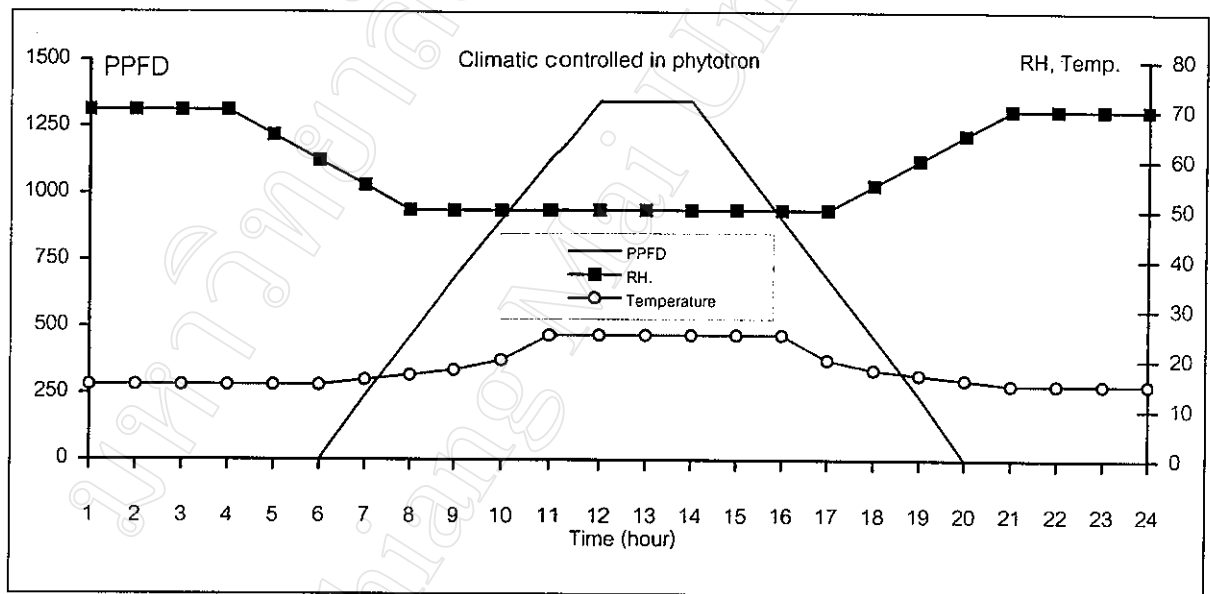
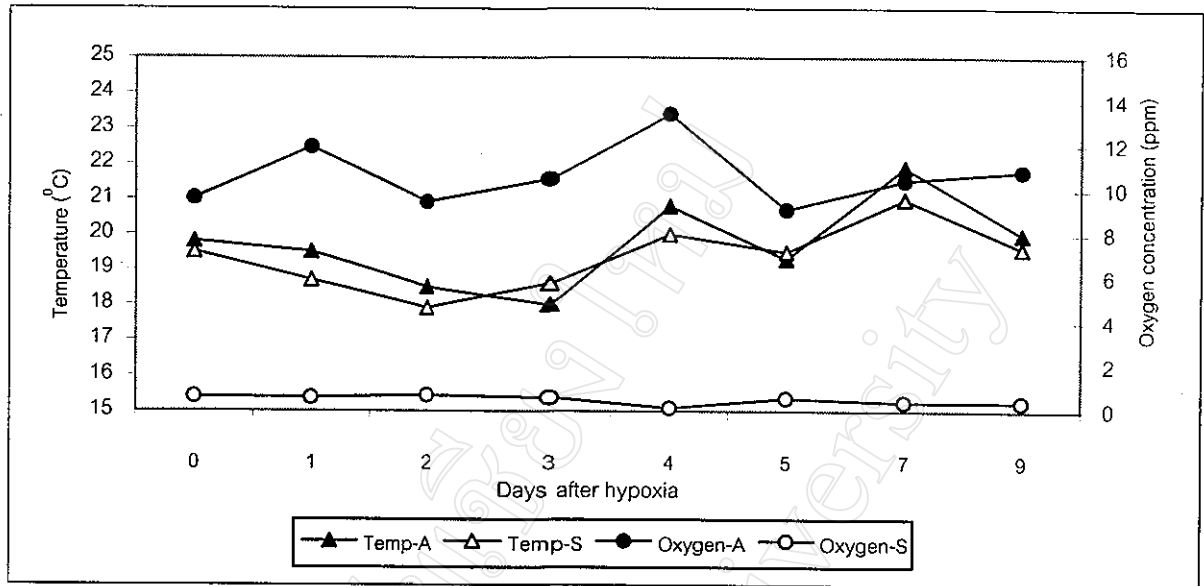

#### Appendix 8 Oxygen concentration and temperature in different nutrient solution (a) and daily climatic control

in plant growth chambers (b) in the laboratory experiment. Note : Daily climatic data in growth

chamber; PPFD = photosynthetic photon flux density ( $\mu\text{mole photons/m}^2/\text{s}$ );

RH.= relative humidity (%); and Temp.= temperature ( $^{\circ}\text{C}$ ).

A= aerated nutrient solution; S = stagnant agar nutrient solution;

## Appendix 9 Preliminary test of the standard ethylene concentration used for GC analysis.

Gas chromatographic profiles of the various standard ethylene concentration (98.8% by volume) mixed with dry air, such as 1, 10, 100, and 1,000 ppm. One ml of mixed gas volume was injected for GC analysis.

The gas chromatography was flame ionization detector (Shimadzu GC-14A) with SUS Packed Column (4mm.OD x 3mm.ID.x 1m long, Porapak N 80/100 mesh). The analysed condition was the sensitivity range = 103, column and inject temperature = 90 oC, detector temperature = 100 oC, dry air flow rate = 100 ml /min and using nitrogen gas as gas carrier. (Ethylene ; CH<sub>2</sub> = CH<sub>2</sub>)

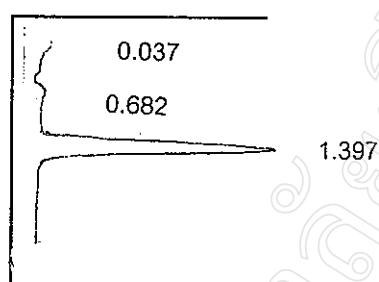

Ethylene : dry air = 1:1,000 (1,000 ppm)

Peak no.	Time	Area	Concentration
1	0.037	65	2.5322
2	0.682	93	3.6218
3	1.397	2420	93.846

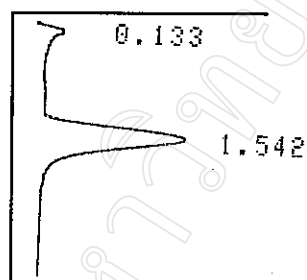

Ethylene : dry air = 1:10,000 (100 ppm)

Peak no.	Time	Area	Concentration
1	0.133	259	9.0952
2	1.542	2590	90.9048

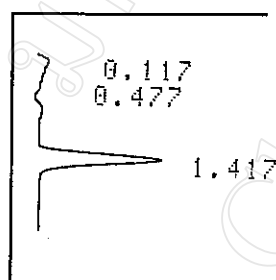

Ethylene : dry air = 1:100,000 (10 ppm)

Peak no.	Time	Area	Concentration
1	0.117	179	13.4124
2	0.477	27	2.0289
3	1.417	1126	84.5588

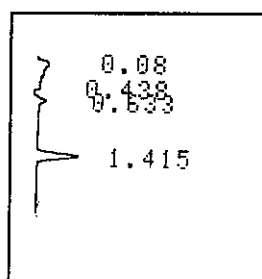

Ethylene : dry air = 1:1,000,000 (1 ppm)

Peak no.	Time	Area	Concentration
1	0.08	163	34.0412
2	0.438	19	3.9330
3	0.633	56	11.5882
4	1.415	242	50.4377

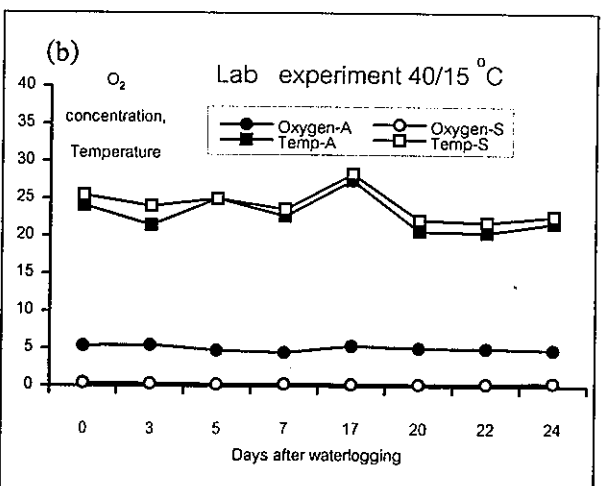
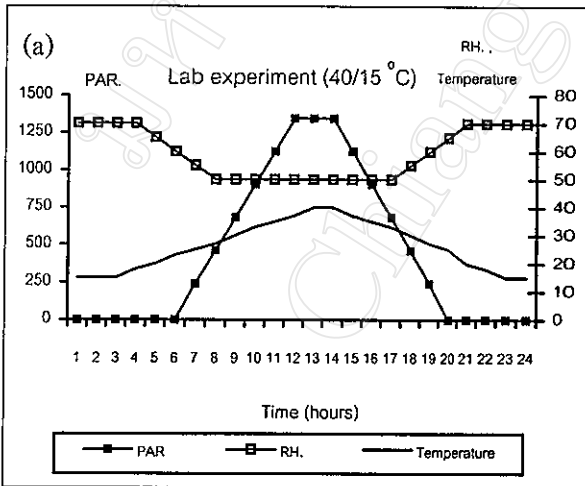
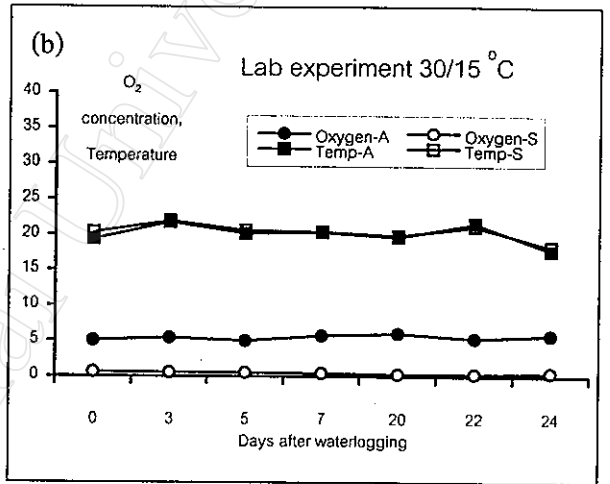
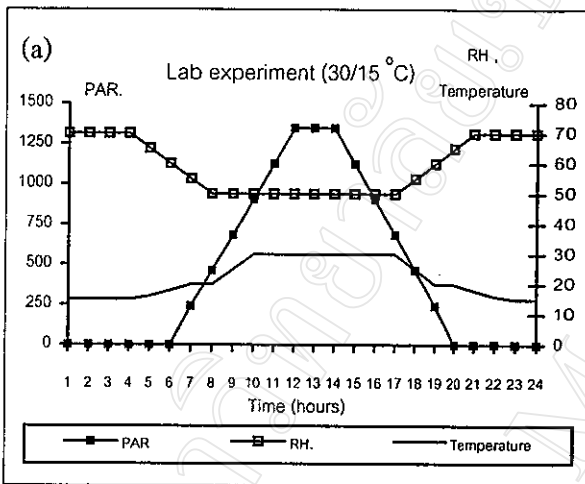
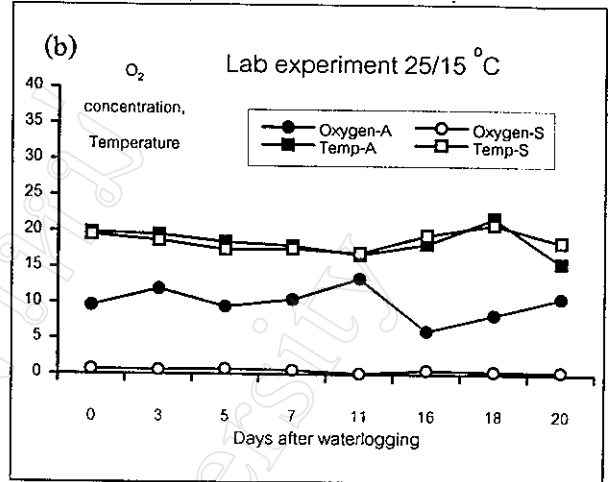
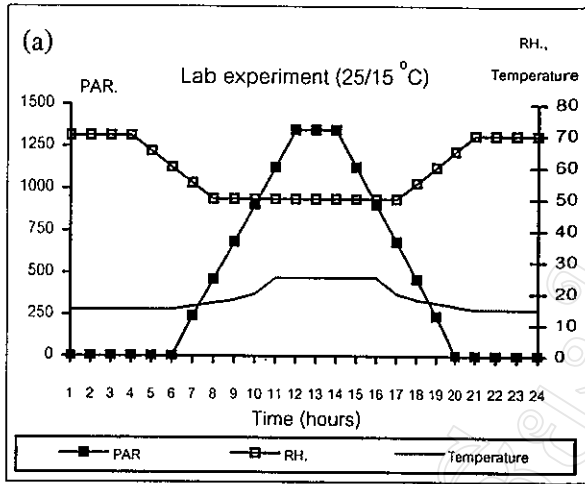

Appendix 10 Oxygen concentration (ppm) and temperature in sub-experiment (a) and climatic diurnal controlled data in plant growth chamber (b) under daily maximum temperature levels; 25/15, 30/15 and 40/15 °C.

Note: A and S= aerated and stagnant agar nutrient solution; PAR = photosynthetic active radiation ( $\mu\text{mole/m}^2/\text{s}$ ), Temperature (°C), RH. = Relative humidity (%), and O<sub>2</sub> concentration (ppm.).

**SUMMARY OUTPUT**

Regression Statistics	
Multiple R	0.9893005
R Square	0.9787155
Adjusted R Square	0.9771952
Standard Error	311.42111
Observations	16

**ANOVA**

	df	SS	MS	F	Significance F
Regression	1	62433355	62433355	643.75494	4.18464E-13
Residual	14	1357763.5	96983.108		
Total	15	63791118			

	Coefficients	Standard Error	t Stat	P-value	Lower 95%	Upper 95%	Lower 95.0%	Upper 95.0%
Intercept	-80.303898	93.9482	-0.8547678	0.4070696	-281.8029259	121.19513	-281.80293	121.19513
X Variable 1	2885.3948	113.72212	25.372326	4.185E-13	2641.484911	3129.3047	2641.4849	3129.3047

**RESIDUAL OUTPUT**

Observation	Predicted Y	Residuals	Std. Residuals
1	-71.93625323	72.93625323	0.242424782
2	-66.45400307	76.45400307	0.254117043
3	-61.54883187	86.54883187	0.287670133
4	-35.29173896	85.29173896	0.28349182
5	-6.726330201	81.7263302	0.271641151
6	42.03684233	57.96315767	0.192657358
7	18.37660477	81.62339523	0.271299017
8	130.0413845	69.95861552	0.23252774
9	284.6985471	-34.69854707	-0.11533068
10	510.3364223	-10.33642233	-0.034356096
11	755.5949824	-5.594982411	-0.018596546
12	1066.063466	-66.06346552	-0.219581079
13	2251.383659	-251.3836594	-0.835546468
14	3870.955774	-870.9557743	-2.894874005
15	5065.220692	-65.22069217	-0.216779878
16	6308.248783	691.7512175	2.299235709

Nitrite Conc.	Absorbance at 540 nm
1	0.0029
10	0.0048
25	0.0065
50	0.0156
75	0.0255
100	0.0424
100	0.0342
200	0.0729
250	0.1265
500	0.2047
750	0.2897
1000	0.3973
2000	0.8081
3000	1.3694
5000	1.7833
7000	2.2141

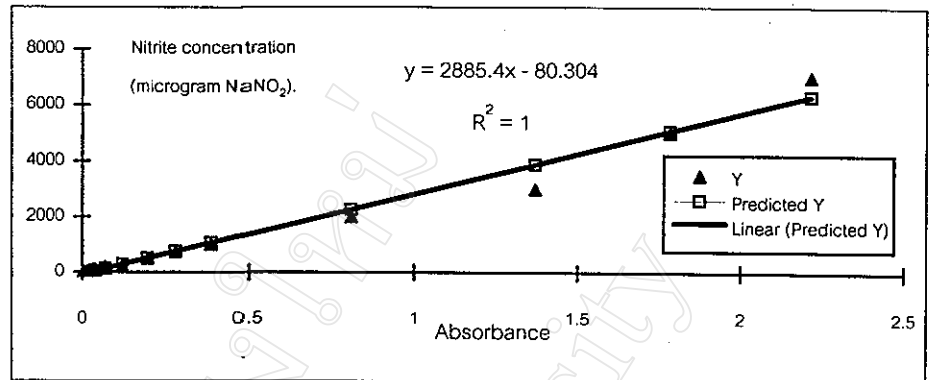

Appendix 11 The standard curve of nitrite concentration for calculating nitrate reductase activity in barley leaves.



**SUMMARY OUTPUT**

<i>Regression Statistics</i>	
Multiple R	0.9829142
R Square	0.9661204
Adjusted R Square	0.9548272
Std. Error	0.0336054
Observations	5

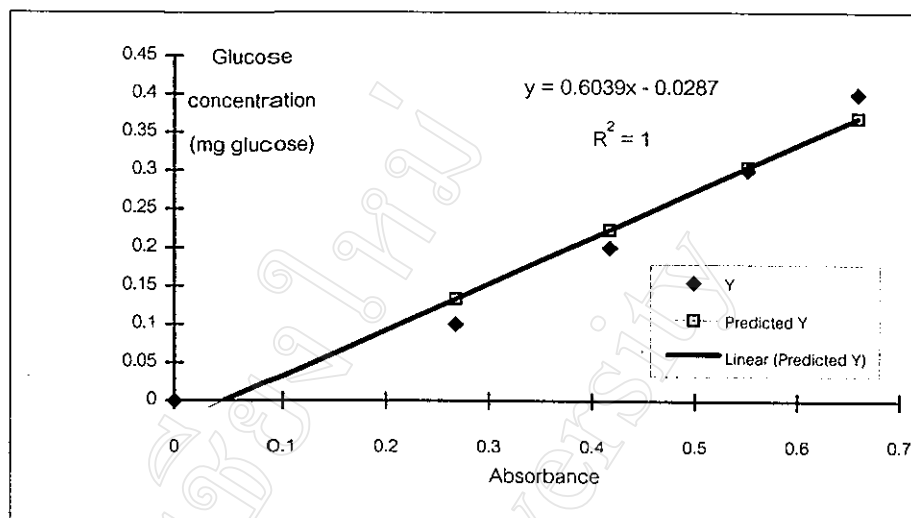
**ANOVA**

	df	SS	MS	F	Significance F
Regression	1	0.096612	0.09661204	85.5488	0.002674051
Residual	3	0.003388	0.00112932		
Total	4	0.1			

	Coefficients	Std. Error	t Stat	P-value	Lower 95%	Upper 95%	Lower 95.0%	Upper 95.0%
Intercept	-0.0287334	0.0289384	-0.99291607	0.3939418	-0.120828542	0.0633617	-0.1208285	0.0633617
X Variable 1	0.6039007	0.0652918	9.24925945	0.0026741	0.396112906	0.8116885	0.3961129	0.8116885

**RESIDUAL OUTPUT**

Observation	Predicted Y	Residuals	Std. Residuals
1	-0.02849	0.028492	0.9789979
2	0.132689	-0.03269	-1.123221
3	0.222852	-0.02285	-0.785195
4	0.304076	-0.00408	-0.140062
5	0.368875	0.031125	1.0694805

Glucose standards (mg glucose /test tube)	Absorbance at 630 nm
0	0.0004
0.1	0.2673
0.2	0.4166
0.3	0.5511
0.4	0.6584

Appendix 12 The standard curve of glucose concentration for calculating total soluble sugar and starch concentration.

$(\text{NH}_4)_2\text{SO}_4$ concentration	Absorbance
0	0
5	0.08
10	0.161
15	0.255
20	0.277
25	0.37

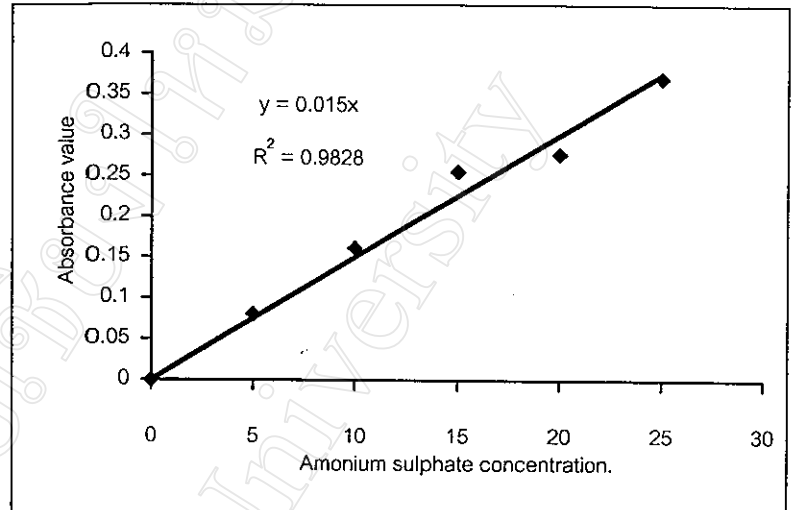

Appendix 13 The standard curve of total nitrogen concentration for calculating total nitrogen in each parts of barley plant.

Appendix 14 The nitrogen ( $\text{NH}_4^+$  - N) content determination from plant samples digested by Kjeldahl method.

The total nitrogen analysis of plant samples generally in Kjeldahl method (conc.  $\text{H}_2\text{SO}_4$  + catalyst) are formed  $\text{NH}_4^+$  - N which analysed total nitrogen by distillation and titration with the exactly acid concentration. However, this procedure was short time to analysis and suitable for a lot of samples, including high accuracy and precision as the previous Kjeldahl method. Janjalernsuk *et al.* (1998) stated that this procedure, the manual colorimetric method (salicylate hypochlorite) was the highest correlation to the distillation and titration method;  $r^2 = 0.996^{**}$ .

**Digestion by Kjeldahl method :**

Mixed acid; 100 ml conc.  $\text{H}_2\text{SO}_4$  + 100 g  $\text{Na}_2\text{SO}_4$  + 1 g Se.

Digestion :

1. To weight 0.5 g of dry milled plant samples and fill 5 ml of mixed acid.
2. To digest the solution until having transparent solution and then adjust the solution volume with 50 ml volumetric flask.
3. To keep the degested solution in the plastic bottle with screw cap and take to analyse total nitrogen by colorimetric method.

**Manual colorimetric method :** as described by Supakhumner (1998) and Janjalernsuk *et al.* (1998).

The preparation of the N1 solution : To solve 34 g sodium salicylate + 25 g sodium citrate + 25 g sodium tartate in 750 ml deionised water. And then add 0.12 g sodium nitroprusside and stir until completely solution. Adjust the total volume to be 1,000 ml with deionised water and keep in the dark bottle or in the dark.

The preparation of the N2 solution : To solve 30 g sodium hydroxide with 750 ml deionised water and keep it to be cool. And add 10 ml sodium hypochlorite (5% available Cl<sub>2</sub>). Adjust the total volume to be 1,000 ml with deionised water and keep in the dark bottle or in the dark.

**Note :** The N1 and N2 solution should be prepared before using 24 hrs.

**Appendix 14 (continued)**

The nitrogen ( $\text{NH}_4^+$ - N) content determination from plant samples digested by Kjeldahl method.

The preparation of the standard concentrations : For measurement the  $\text{NH}_4^+$ - N concentration in the digested samples, 1,000 ppm  $\text{NH}_4$ - stock solution will be prepared for standard curve. To solve 4.714 g of  $(\text{NH}_4)_2\text{SO}_4$  , dried at 105 °C before using, with deionised water in 1,000 ml of volumetric flask and keep in the refrigerator. To prepare working standard concentrations, such as 0, 5, 10, 15, 20 and 25 ppm of  $(\text{NH}_4)_2\text{SO}_4$  by adding conc.  $\text{H}_2\text{SO}_4$  for adjust equally to  $\text{H}_2\text{SO}_4$  concentration in the digested sample solution.

Measurement : To pipette 0.2 ml of the working standard concentrations or the digested sample solution in test tubes. Add 0.5 ml of the N1 solution and stir the mixed solution and then keep for 15 min. Thus, add 0.5 ml of the N2 solution and stir the mixed solution and then keep for 1 hour or until dark green blue appearance consistently. So measure absorbance at the wave length 625 nm with Spectrophotometry.

.....

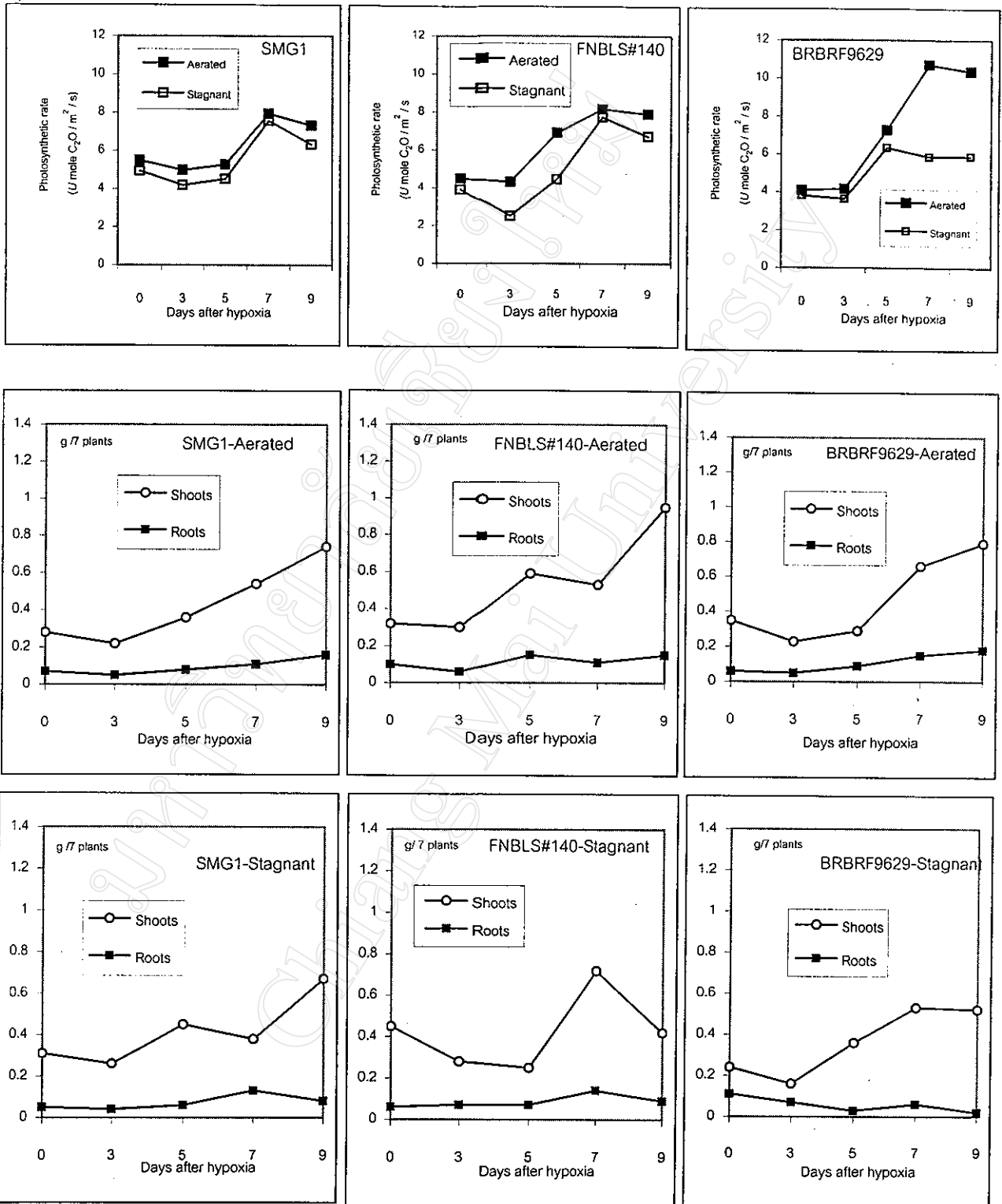

Appendix 15 The photosynthetic rate and dry matter accumulation of barley genotypes grown in aerated and stagnant agar nutrient solution in the growth chamber at 20/15 °C (day/night temperature).

Note Data were means of four replications.

Appendix 16 Listing of functions and subroutines of the source code used in the mechanistic modeling of SMG1 genotype.

```

Initial_TDM(t) = Initial_TDM(t - dt) + (PhsRate - ShGRate - RtGRate) * dt
INIT Initial_TDM = 4
INFLOWS:
    PhsRate = PhsAssimHr
OUTFLOWS:
    ShGRate = IF (Water_Treatment=1) then ((0.3196*ActTmp)-0.0629) else ((0.0185*ActTmp*ActTmp)
        -(0.1147*ActTmp)+0.3555)
    RtGRate=IF(Water_Treatment=1) then((-0.0278*(ActTmp-4))+0.1592)else ((0.0012*(ActTmp-4)*(ActTmp-4))
        -(0.0283*(ActTmp-4))+0.0862)
    RtDM(t) = RtDM(t - dt) + (RtGRate - RtResMain) * dt
INIT RtDM = (Initial_TDM*RtParFct)
INFLOWS:
    RtGRate = IF (Water_Treatment=1) then ((-0.0278*(ActTmp-4))+0.1592) else ((0.0012*(ActTmp-4)*(ActTmp-4))
        -(0.0283*(ActTmp-4))+0.0862)
OUTFLOWS:
    RtResMain = (RtDM*0.00015*Q10)
    ShDM(t) = ShDM(t - dt) + (ShGRate - ShResMain) * dt
INIT ShDM = Initial_TDM*ShParFct
INFLOWS:
    ShGRate = IF (Water_Treatment=1) then ((0.3196*ActTmp)-0.0629) else ((0.0185*ActTmp*ActTmp)
        -(0.1147*ActTmp)+0.3555)
OUTFLOWS:
    ShResMain = (ShDM*0.75*Q10)
ActTmp = MaxDailyTemp*TempChmbFct
AerPhs = ((-1.3741*ActTmp*ActTmp)+(7.0826*ActTmp)-2.9707)*LeafTFct
ConvCO2 = (GrossPhs*1000)/(44*10000)
ConvertDM = NetGlu*(180)
ConvPAR = 4.2553*VS_SolarRad*SolarChmbFct
GrossPhs = PLMX*(1.0-EXP(-PLEA*ConvPAR/PLMX))
MaxDailyTemp = 20

```

## Appendix 16 (continued)

Listing of functions and subroutines of the source code used in the mechanistic modeling of SMG1 genotype.

NetGlu = (ConvCO2)/6

PhsAssimHr = (ConvertDM/0.92)\*(40/300)

PhsBar = IF (Water\_Treatment = 1) then (AerPhs) else (WLPhs)

PLMX = (PhsBar)\*((44\*10000\*60\*60)/(1000000\*1000))

Q10 = IF ((ActTmp-10)/10)>2 then (2) else ((ActTmp-10)/10)

RtParFct = IF (Water\_Treatment=1) then (0.19) else (0.12)

ShParFct = IF (Water\_Treatment=1) then (0.81) else (0.88)

VS\_SolarRad = VS\_Solar\_Radiation\*SolarChmbFct

VS\_Solar\_Radiation = 1346

Water\_Treatment = 1

WLPhs = ((-1.0992\*ActTmp\*ActTmp)+(5.1945\*ActTmp)-1.4261)\*LeafTFct

LeafTFct = GRAPH(ActTmp)

(0.00, 0.01), (5.00, 0.4), (10.0, 0.7), (15.0, 0.9), (20.0, 1.00), (25.0, 1.00), (30.0, 0.9), (35.0, 0.8), (40.0, 0.5)

PLEA = GRAPH(ActTmp)

(0.00, 0.5), (10.0, 0.5), (20.0, 0.45), (30.0, 0.3), (40.0, 0.1), (50.0, 0.01)

SolarChmbFct = GRAPH(time)

(0.00, 0.00), (6.00, 0.071), (12.0, 1.00), (18.0, 0.429), (24.0, 0.00), (30.0, 0.071), (36.0, 1.00), (42.0, 0.429), (48.0, 0.00),

(54.0, 0.071), (60.0, 1.00), (66.0, 0.429), (72.0, 0.00), (78.0, 0.071), (84.0, 1.00), (90.0, 0.429), (96.0, 0.00), (102, 0.071),

(108, 1.00), (114, 0.429), (120, 0.00), (126, 0.071), (132, 1.00), (138, 0.429), (144, 0.00), (150, 0.071), (156, 1.00),

(162, 0.429), (168, 0.00), (174, 0.071), (180, 1.00), (186, 0.429), (192, 0.00), (198, 0.071), (204, 1.00), (210, 0.429), (216, 0.00)

TempChmbFct = GRAPH(time)

(0.00, 0.375), (6.00, 0.575), (12.0, 0.925), (18.0, 0.75), (24.0, 0.375), (30.0, 0.575), (36.0, 0.925), (42.0, 0.75), (48.0, 0.375),

(54.0, 0.575), (60.0, 0.925), (66.0, 0.75), (72.0, 0.375), (78.0, 0.575), (84.0, 0.925), (90.0, 0.75), (96.0, 0.375), (102, 0.575),

(108, 0.925),(114, 0.75),(120, 0.375),(126, 0.575),(132, 0.925),(138, 0.75),(144, 0.375),(150, 0.575),(156, 0.925),(162, 0.75)

, (168, 0.375), (174, 0.575), (180, 0.925), (186, 0.75), (192, 0.375), (198, 0.575), (204, 0.925), (210, 0.75), (216, 0.375)

Appendix 17 Listing of functions and subroutines of the source code used in the mechanistic modeling of FNBLs#140 genotype.

U:

```

Initial_TDM(t) = Initial_TDM(t - dt) + (PhsRate - ShGRate - RtGRate) * dt
INIT Initial_TDM = 4
INFLOWS:
PhsRate = PhsAssimHr
OUTFLOWS:
ShGRate = IF (Water_Treatment=1) then ((0.2674*ActTmp)+0.028) else ((0.0688*ActTmp)+0.0635)
RtGRate = IF (Water_Treatment=1) then ((-0.0173*(ActTmp-4)*(ActTmp-4))+(0.0419*(ActTmp-4))+0.1495)
          else ((-0.0061*(ActTmp-4)*(ActTmp-4))-(-0.0031*(ActTmp-4))+0.0604)
RtDM(t) = RtDM(t - dt) + (RtGRate - RtResMain) * dt
INIT RtDM = Initial_TDM*RtParFct
INFLOWS:
RtGRate = IF (Water_Treatment=1) then ((-0.0173*(ActTmp-4)*(ActTmp-4))+(0.0419*(ActTmp-4))+0.1495) else
          ((-0.0061*(ActTmp-4)*(ActTmp-4))-(-0.0031*(ActTmp-4))+0.0604)
OUTFLOWS:
RtResMain = (RtDM*0.00015*Q10)
ShDM(t) = ShDM(t - dt) + (ShGRate - ShResMain) * dt
INIT ShDM = Initial_TDM*ShParFct
INFLOWS:
ShGRate = IF (Water_Treatment=1) then ((0.2674*ActTmp)+0.028) else ((0.0688*ActTmp)+0.0635)
OUTFLOWS:
ShResMain = (ShDM*0.75*Q10)
ActTmp = MaxDailyTemp*TempChmbFct
AerPhs = ((-0.714*(ActTmp)*(ActTmp))+4.7023*(ActTmp))-(-0.8934))*LeafTFct
ConvCO2 = (GrossPhs*1000)/(44*10000)
ConvertDM = NetGlu*(180)
ConvPAR = 4.2553*VS_SolarRad*SolarChmbFct
GrossPhs = PLMX*(1.0-EXP(-PLEA*ConvPAR/PLMX))
MaxDailyTemp = 20
NetGlu = (ConvCO2)/6
PhsAssimHr = (ConvertDM/0.92)*(40/300)

```



## Appendix 17 (continued)

Listing of functions and subroutines of the source code used in the mechanistic modeling of FNBS#140 genotype

```

PhsBar = IF (Water_Treatment = 1) then (AerPhs) else (WLPhs)
PLMX = (PhsBar)*((44*10000*60*60)/(1000000*1000))
Q10 = IF ((ActTmp-10)/10) >2 then (2) else ((ActTmp-10)/10)
RtParFct = IF (Water_Treatment=1) then (0.222) else (0.154)
ShParFct = IF (Water_Treatment=1) then (0.778) else (0.846)
VS_SolarRad = VS_Solar_Radiation*SolarChmbFct
VS_Solar_Radiation = 1346
Water_Treatment = 1
WLPhs = ((-1.1319*(ActTmp)*(ActTmp)) + (5.6348*(ActTmp)) - (2.355))*(LeafTFct)
LeafTFct = GRAPH(ActTmp)
(0.00, 0.01), (5.00, 0.4), (10.0, 0.7), (15.0, 0.9), (20.0, 1.00), (25.0, 1.00), (30.0, 0.9), (35.0, 0.8), (40.0, 0.5)
PLEA = GRAPH(ActTmp)
(0.00, 0.5), (10.0, 0.5), (20.0, 0.45), (30.0, 0.3), (40.0, 0.1), (50.0, 0.01)
SolarChmbFct = GRAPH(time)
(0.00, 0.00), (6.00, 0.071), (12.0, 1.00), (18.0, 0.429), (24.0, 0.00), (30.0, 0.071), (36.0, 1.00), (42.0, 0.429), (48.0, 0.00),
(54.0, 0.071), (60.0, 1.00), (66.0, 0.429), (72.0, 0.00), (78.0, 0.071), (84.0, 1.00), (90.0, 0.429), (96.0, 0.00), (102, 0.071),
(108, 1.00), (114, 0.429), (120, 0.00), (126, 0.071), (132, 1.00), (138, 0.429), (144, 0.00), (150, 0.071), (156, 1.00),
(162, 0.429), (168, 0.00), (174, 0.071), (180, 1.00), (186, 0.429), (192, 0.00), (198, 0.071), (204, 1.00), (210, 0.429), (216, 0.00)
TempChmbFct = GRAPH(time)
(0.00, 0.375), (6.00, 0.575), (12.0, 0.925), (18.0, 0.75), (24.0, 0.375), (30.0, 0.575), (36.0, 0.925), (42.0, 0.75), (48.0, 0.375),
(54.0, 0.575), (60.0, 0.925), (66.0, 0.75), (72.0, 0.375), (78.0, 0.575), (84.0, 0.925), (90.0, 0.75), (96.0, 0.375), (102, 0.575),
(108, 0.925), (114, 0.75), (120, 0.375), (126, 0.575), (132, 0.925), (138, 0.75), (144, 0.375), (150, 0.575), (156, 0.925), (162, 0.75)
, (168, 0.375), (174, 0.575), (180, 0.925), (186, 0.75), (192, 0.375), (198, 0.575), (204, 0.925), (210, 0.75), (216, 0.375)

```

Appendix 18 Listing of functions and subroutines of the source code used in the mechanistic modeling of BRBRF9629 genotype

```

Initial_TDM(t) = Initial_TDM(t - dt) + (PhsRate - ShGRate - RtGRate) * dt
INIT Initial_TDM = 4
INFLOWS:
PhsRate = PhsAssimHr
OUTFLOWS:
ShGRate = IF (Water_Treatment=1) then ((0.3193*ActTmp)-0.0785) else ((0.1471*ActTmp)-0.0721)
RtGRate = IF (Water_Treatment=1) then ((-0.0305*(ActTmp-4))+0.1921) else ((-0.0075*(ActTmp-4)*(ActTmp-4))
+ (0.0215*(ActTmp-4))+0.0224)
RtDM(t) = RtDM(t - dt) + (RtGRate - RtResMain) * dt
INIT RtDM = Initial_TDM*RtParFct
INFLOWS:
RtGRate = IF (Water_Treatment=1) then ((-0.0305*(ActTmp-4))+0.1921) else ((-0.0075*(ActTmp-4)*(ActTmp-4))
+ (0.0215*(ActTmp-4))+0.0224)
OUTFLOWS:
RtResMain = (RtDM*0.00015*Q10)
ShDM(t) = ShDM(t - dt) + (ShGRate - ShResMain) * dt
INIT ShDM = Initial_TDM*ShParFct
INFLOWS:
ShGRate = IF (Water_Treatment=1) then ((0.3193*ActTmp)-0.0785) else ((0.1471*ActTmp)-0.0721)
OUTFLOWS:
ShResMain = (ShDM*0.75*Q10)
ActTmp = MaxDailyTemp*TempChmbFct
AerPhs = ((-1.0661*(ActTmp)*(ActTmp))+ (6.1521*(ActTmp)) - (2.4066))*LeafTFct
ConvCO2 = (GrossPhs*1000)/(44*10000)
ConvertDM = NetGlu*(180)
ConvPAR = 4.2553*VS_SolarRad*SolarChmbFct
GrossPhs = PLMX*(1.0-EXP(-PLEA*ConvPAR/PLMX))
MaxDailyTemp = 20
NetGlu = (ConvCO2)/6
PhsAssimHr = (ConvertDM/0.92)*(40/300)

```

## Appendix 18 (continued)

Listing of functions and subroutines of the source code used in the mechanistic modeling of BRBRF9629 genotype

```

PhsBar = IF (Water_Treatment =1) then (AerPhs) else (WLPhs)
PLMX = (PhsBar)*((44*10000*60*60)/(1000000*1000))
Q10 = IF ((ActTmp-10)/10) >2 then (2) else ((ActTmp-10)/10)
RtParFct = IF (Water_Treatment=1) then (0.192) else (0.1385)
ShParFct = IF (Water_Treatment=1) then (0.80) else (0.832)
VS_SolarRad = VS_Solar_Radiation*SolarChmbFct
VS_Solar_Radiation = 1346
Water_Treatment = 1
WLPhs = ((-0.7835*(ActTmp)*(ActTmp)) + (4.0289*(ActTmp)) - (1.4616))*(LeafTFct)
LeafTFct = GRAPH(ActTmp)
(0.00, 0.01), (5.00, 0.4), (10.0, 0.7), (15.0, 0.9), (20.0, 1.00), (25.0, 1.00), (30.0, 0.9), (35.0, 0.8), (40.0, 0.5)
PLEA = GRAPH(ActTmp)
(0.00, 0.5), (10.0, 0.5), (20.0, 0.45), (30.0, 0.3), (40.0, 0.1), (50.0, 0.01)
SolarChmbFct = GRAPH(time)
(0.00, 0.00), (6.00, 0.071), (12.0, 1.00), (18.0, 0.429), (24.0, 0.00), (30.0, 0.071), (36.0, 1.00), (42.0, 0.429), (48.0, 0.00),
(54.0, 0.071), (60.0, 1.00), (66.0, 0.429), (72.0, 0.00), (78.0, 0.071), (84.0, 1.00), (90.0, 0.429), (96.0, 0.00), (102, 0.071),
(108, 1.00), (114, 0.429), (120, 0.00), (126, 0.071), (132, 1.00), (138, 0.429), (144, 0.00), (150, 0.071), (156, 1.00),
(162, 0.429), (168, 0.00), (174, 0.071), (180, 1.00), (186, 0.429), (192, 0.00), (198, 0.071), (204, 1.00), (210, 0.429), (216, 0.00)
TempChmbFct = GRAPH(time)
(0.00, 0.375), (6.00, 0.575), (12.0, 0.925), (18.0, 0.75), (24.0, 0.375), (30.0, 0.575), (36.0, 0.925), (42.0, 0.75), (48.0, 0.375),
(54.0, 0.575), (60.0, 0.925), (66.0, 0.75), (72.0, 0.375), (78.0, 0.575), (84.0, 0.925), (90.0, 0.75), (96.0, 0.375), (102, 0.575),
(108, 0.925), (114, 0.75), (120, 0.375), (126, 0.575), (132, 0.925), (138, 0.75), (144, 0.375), (150, 0.575), (156, 0.925), (162, 0.75)
, (168, 0.375), (174, 0.575), (180, 0.925), (186, 0.75), (192, 0.375), (198, 0.575), (204, 0.925), (210, 0.75), (216, 0.375)

```

Appendix 19 Observed and Simulated data of the shoots and roots of barley genotypes during aerated and hypoxic condition at ambient temperatures for model testing.

<i>LAB experiment 20/15 C</i>						<i>LAB experiment 25/15 C</i>									
<u>Aerated NS</u>	DAYS	0	3	5	7	9	<u>Aerated NS</u>	DAYS	0	3	5	7	9		
SMG1	Obs-Shoot	4.6	7.8	9.6	9.5	10.6	SMG1	Obs-Shoot	2.8	6.2	6.6	7.4	9.4		
	Obs-Root	0.4	1	1.2	1.4	1.6		Obs-Root	0.7	0.5	0.8	1.1	1.6		
	Sim-Shoot	5.99	10	10.6	11	10.6		Sim-Shoot	2.91	7.45	7.96	8.79	10.2		
	Sim-Root	0.63	1	1.28	1.6	1.93		Sim-Root	0.67	0.69	0.71	0.72	0.74		
	DAYS	0	3	5	7	9		DAYS	0	3	5	7	9		
FNBLS140	Obs-Shoot	7.2	7.6	9.4	9.4	10	FNBLS140	Obs-Shoot	3.2	5	6.6	7.4	8.5		
	Obs-Root	0.8	1	2	2.2	2		Obs-Root	0.6	0.7	1.5	1.8	2.2		
	Sim-Shoot	8.18	8.5	9.04	11	11.2		Sim-Shoot	3.52	6.32	7.47	8.71	10.7		
	Sim-Root	1.02	1.2	1.44	1.7	1.87		Sim-Root	0.84	0.84	0.84	0.83	0.83		
	DAYS	0	3	5	7	9		DAYS	0	3	5	7	9		
BRBRF9629	Obs-Shoot	7.8	7.4	9	9.6	9.6	BRBRF9629	Obs-Shoot	3.5	6.3	6.9	6.6	7.9		
	Obs-Root	0.8	1.8	1.6	1.4	1.3		Obs-Root	0.6	0.5	0.9	1.5	1.8		
	Sim-Shoot	8.33	9.9	9.94	10	10.6		Sim-Shoot	3.23	7.59	7.79	7.94	8.76		
	Sim-Root	0.97	1.5	2.08	2.6	3.19		Sim-Root	0.82	0.87	0.93	0.99	1.04		
	DAYS	0	3	5	7	9		DAYS	0	3	5	7	9		
<u>Stagnant NS</u>	DAYS	0	3	5	7	9	<u>Stagnant NS</u>	DAYS	0	3	5	7	9		
	SMG1	Obs-Shoot	7.6	7.4	8.8	9		9.8	SMG1	Obs-Shoot	4.6	6.4	6.8	7	7
		Obs-Root	0.4	0.8	0.8	0.8		1		Obs-Root	0.04	0.08	0.1	0.29	0.4
		Sim-Shoot	7.15	7.4	7.9	8.8		8.84		Sim-Shoot	5.31	7.32	7.47	7.71	7.61
		Sim-Root	0.48	0.5	0.49	0.5		0.49		Sim-Root	0.43	0.43	0.43	0.43	0.42
DAYS	0	3	5	7	9	DAYS	0	3	5	7	9				
FNBLS140	Obs-Shoot	3.1	3.9	4.3	4.5	4.34	FNBLS140	Obs-Shoot	2.5	2.8	3	3.2	4.2		
	Obs-Root	0.4	0.8	1	1	0.8		Obs-Root	0.4	0.5	0.5	0.7	0.6		
	Sim-Shoot	3.42	4	5.23	5.2	5.26		Sim-Shoot	2.15	2.9	3.63	4.4	4.99		
	Sim-Root	0.54	0.5	0.54	0.5	0.53		Sim-Root	0.45	0.29	0.18	0.12	0.07		
	DAYS	0	3	5	7	9		DAYS	0	3	5	7	9		
BRBRF9629	Obs-Shoot	3.8	3.6	4.8	6	6.2	BRBRF9629	Obs-Shoot	2.4	3.6	3.6	4.3	5.2		
	Obs-Root	0.8	1	1	1.4	1		Obs-Root	0.3	0.4	0.4	0.5	0.6		
	Sim-Shoot	4.4	4.5	5.92	7.7	7.65		Sim-Shoot	3.39	3.46	3.61	3.99	4.63		
	Sim-Root	0.64	0.7	0.66	0.7	0.68		Sim-Root	0.42	0.41	0.41	0.41	0.41		
	DAYS	0	3	5	7	9		DAYS	0	3	5	7	9		

## Appendix 19 (continued)

Observed and Simulated data of the shoots and roots of barley genotypes during aerated and hypoxic condition at ambient temperatures for model testing.

<i>LAB experiment 30/15 C</i>						<i>LAB experiment 40/15 C</i>									
<u>Aerated NS</u>	DAYS	0	3	5	7	9	<u>Aerated NS</u>	DAYS	0	3	5	7	9		
SMG1	Obs-Shoot	4	7.5	7	8.7	8.5	SMG1	Obs-Shoot	3.4	3.6	5.2	6.7	7.8		
	Obs-Root	0.4	1	1.4	1.1	1.2		Obs-Root	0.2	0.6	0.6	0.7	0.6		
	Sim-Shoot	5.03	6.55	6.81	7.2	8.4		Sim-Shoot	4.43	4.64	6.65	7.21	8.74		
	Sim-Root	0.84	0.83	0.82	0.8	0.8		Sim-Root	0.44	0.44	0.43	0.43	0.42		
	DAYS	0	3	5	7	9		DAYS	0	3	5	7	9		
FNBLS140	Obs-Shoot	5.1	6.6	7	8.9	9.7	FNBLS140	Obs-Shoot	3.6	4.7	6.6	7.6	7.2		
	Obs-Root	1.8	2	2.2	2	2.5		Obs-Root	0.2	0.3	0.38	0.44	0.5		
	Sim-Shoot	6.42	7.17	8.23	9.6	9.6		Sim-Shoot	3.08	5.46	6.33	6.76	6.76		
	Sim-Root	2.11	2.09	2.08	2.1	2.1		Sim-Root	0.84	0.83	0.82	0.81	0.81		
	DAYS	0	3	5	7	9		DAYS	0	3	5	7	9		
BRBRF9629	Obs-Shoot	6.9	7.3	6.9	9.7	10	BRBRF9629	Obs-Shoot	3.4	6	6.5	6.9	7.2		
	Obs-Root	0.9	0.8	0.8	1.2	1.2		Obs-Root	0.2	0.3	0.4	0.68	0.84		
	Sim-Shoot	6.79	7.14	7.63	8.4	9.6		Sim-Shoot	4.72	6.78	7.6	7.94	7.94		
	Sim-Root	1.42	1.41	1.4	1.4	1.4		Sim-Root	0.77	0.76	0.75	0.74	0.73		
	DAYS	0	3	5	7	9		DAYS	0	3	5	7	9		
<u>Stagnant NS</u>	DAYS	0	3	5	7	9	<u>Stagnant NS</u>	DAYS	0	3	5	7	9		
	SMG1	Obs-Shoot	4.4	5.6	6.8	7		7	SMG1	Obs-Shoot	3.6	3.4	4.8	4.8	5
		Obs-Root	0.4	0.6	1	1.8		2		Obs-Root	0.1	0.08	0.08	0.08	0.04
		Sim-Shoot	5.34	7.24	7.34	7.9		8.3		Sim-Shoot	2.78	4.64	5.83	5.83	5.75
		Sim-Root	0.41	0.96	1.52	2.1		2.7		Sim-Root	0.38	0.11	0.03	0.01	0
DAYS	0	3	5	7	9	DAYS	0	3	5	7	9				
FNBLS140	Obs-Shoot	2.4	2	2.9	2.8	2.7	FNBLS140	Obs-Shoot	1.2	1.6	2	2.4	2.5		
	Obs-Root	0.2	0.1	0.1	0.1	0.1		Obs-Root	0.1	0.2	0.3	0.38	0.5		
	Sim-Shoot	1.84	2.59	2.21	1.9	1.9		Sim-Shoot	1.33	1.46	1.55	1.65	1.78		
	Sim-Root	0.83	0.83	0.82	0.8	0.8		Sim-Root	0.65	0.64	0.63	0.62	0.62		
	DAYS	0	3	5	7	9		DAYS	0	3	5	7	9		
BRBRF9629	Obs-Shoot	2.2	5.5	6.5	6.6	7.3	BRBRF9629	Obs-Shoot	2.6	3.8	3.7	3.8	3.7		
	Obs-Root	0.2	0.3	0.3	0.4	0.4		Obs-Root	0.3	0.3	0.2	0.2	0.2		
	Sim-Shoot	2.98	4.72	6.78	7.6	6.8		Sim-Shoot	2.86	3.26	3.4	3.67	3.4		
	Sim-Root	0.41	0.76	0.75	0.7	0.7		Sim-Root	0.41	0.41	0.41	0.4	0.4		
	DAYS	0	3	5	7	9		DAYS	0	3	5	7	9		

Appendix 20 Observed and Simulated data of the shoots and roots of barley genotypes during aerated and hypoxic condition at ambient temperatures for model validation.

<i>LAB experiment 20/15 C</i>						<i>LAB experiment 25/15 C</i>									
<u>Aerated NS</u>	DAYS	0	3	5	7	9	<u>Aerated NS</u>	DAYS	0	3	5	7	9		
SMG1	Obs-Shoot	6	8.9	9.6	9.8	11	SMG1	Obs-Shoot	3.8	5.2	7.5	7.6	9.2		
	Obs-Root	0.4	0.8	1	1.4	1.6		Obs-Root	0.7	0.5	0.8	1	1.1		
	Sim-Shoot	6	10	11	11	11		Sim-Shoot	3.9	8.5	9	9.8	11		
	Sim-Root	0.6	1	1.3	1.6	1.9		Sim-Root	0.7	0.7	0.7	0.7	0.7		
	DAYS	0	3	5	7	9		DAYS	0	3	5	7	9		
FNBLS140	Obs-Shoot	8.2	8.5	8.8	9.5	10	FNBLS140	Obs-Shoot	3.2	4.5	5.8	6.5	7.2		
	Obs-Root	0.9	1	1.2	1.5	1.3		Obs-Root	0.6	0.7	0.8	0.8	0.9		
	Sim-Shoot	8.2	8.5	9	11	11		Sim-Shoot	3.5	6.3	7.5	8.7	11		
	Sim-Root	1	1.2	1.4	1.7	1.9		Sim-Root	0.8	0.8	0.8	0.8	0.8		
	DAYS	0	3	5	7	9		DAYS	0	3	5	7	9		
BRBRF9629	Obs-Shoot	7.8	8	8.5	8.7	9.1	BRBRF9629	Obs-Shoot	3.5	5.3	5.9	6.6	7.9		
	Obs-Root	0.8	1.1	1.3	1.5	1.8		Obs-Root	0.6	0.6	0.7	0.9	0.9		
	Sim-Shoot	8.3	9.9	9.9	10	11		Sim-Shoot	3.2	7.6	7.8	7.9	8.8		
	Sim-Root	1	1.5	2.1	2.6	3.2		Sim-Root	0.8	0.9	0.9	1	1		
	DAYS	0	3	5	7	9		DAYS	0	3	5	7	9		
<u>Stagnant NS</u>	DAYS	0	3	5	7	9	<u>Stagnant NS</u>	DAYS	0	3	5	7	9		
	SMG1	Obs-Shoot	7.6	7.4	7.8	8		8.5	SMG1	Obs-Shoot	4.6	5.4	6.8	7	6.7
		Obs-Root	0.4	0.4	0.5	0.5		0.5		Obs-Root	0.3	0.4	0.4	0.4	0.6
		Sim-Shoot	7.2	7.4	7.9	8.8		8.8		Sim-Shoot	5.3	7.3	7.5	7.7	7.6
		Sim-Root	0.5	0.5	0.5	0.5		0.5		Sim-Root	0.4	0.4	0.4	0.4	0.4
DAYS	0	3	5	7	9	DAYS	0	3	5	7	9				
FNBLS140	Obs-Shoot	3.1	3.5	4.3	4.5	4.3	FNBLS140	Obs-Shoot	2	2.1	2.5	3.2	4.2		
	Obs-Root	0.4	0.6	0.7	0.7	0.7		Obs-Root	0.4	0.5	0.5	0.7	0.6		
	Sim-Shoot	3.4	4	5.2	5.2	5.3		Sim-Shoot	2.2	2.9	3.6	4.4	5		
	Sim-Root	0.5	0.5	0.5	0.5	0.5		Sim-Root	0.5	0.3	0.2	0.1	0.1		
	DAYS	0	3	5	7	9		DAYS	0	3	5	7	9		
BRBRF9629	Obs-Shoot	3.8	3.6	3.9	5.6	6.2	BRBRF9629	Obs-Shoot	2.4	2.6	3.2	3.5	3.4		
	Obs-Root	0.4	0.5	0.5	0.4	0.6		Obs-Root	0.3	0.4	0.4	0.3	0.4		
	Sim-Shoot	4.4	4.5	5.9	7.7	7.7		Sim-Shoot	3.4	3.5	3.6	4	4.6		
	Sim-Root	0.6	0.7	0.7	0.7	0.7		Sim-Root	0.4	0.4	0.4	0.4	0.4		

## Appendix 20 (continued)

Observed and Simulated data of the shoots and roots of barley genotypes during aerated and hypoxic condition at ambient temperatures for model validation.

<i>LAB experiment 30/15 C</i>						<i>LAB experiment 40/15 C</i>											
<u>Aerated NS</u>			DAYS	0	3	5	7	9	<u>Aerated NS</u>			DAYS	0	3	5	7	9
SMG1	Obs-Shoot		4	5.2	6.7	8.7	9.1		SMG1	Obs-Shoot		3.4	3.6	5.2	7.7	8.8	
	Obs-Root		0.4	1	1.4	1.5	1.1			Obs-Root		0.2	0.6	0.6	0.7	0.6	
	Sim-Shoot		5	6.6	6.8	7.2	8.4			Sim-Shoot		4.4	4.6	6.7	7.2	8.7	
	Sim-Root		0.8	0.8	0.8	0.8	0.8			Sim-Root		0.4	0.4	0.4	0.4	0.4	
	DAYS		0	3	5	7	9			DAYS		0	3	5	7	9	
FNBLS140	Obs-Shoot		6	6.6	6.8	7.4	8		FNBLS140	Obs-Shoot		3	3.7	4.6	6	6.7	
	Obs-Root		1.8	2	2.2	2	2.5			Obs-Root		0.2	0.3	0.4	0.4	0.5	
	Sim-Shoot		6.4	7.2	8.2	9.6	9.6			Sim-Shoot		3.1	5.5	6.3	6.8	6.8	
	Sim-Root		2.1	2.1	2.1	2.1	2.1			Sim-Root		0.8	0.8	0.8	0.8	0.8	
	DAYS		0	3	5	7	9			DAYS		0	3	5	7	9	
BRBRF9629	Obs-Shoot		6.9	7.3	7.5	8.2	8.9		BRBRF9629	Obs-Shoot		4.5	5.6	6.2	6.9	7.2	
	Obs-Root		0.9	0.8	0.9	1.2	1.2			Obs-Root		0.2	0.3	0.4	0.5	0.6	
	Sim-Shoot		6.8	7.1	7.6	8.4	9.6			Sim-Shoot		4.7	6.8	7.6	7.9	7.9	
	Sim-Root		1.4	1.4	1.4	1.4	1.4			Sim-Root		0.8	0.8	0.8	0.7	0.7	
	DAYS		0	3	5	7	9			DAYS		0	3	5	7	9	
<u>Stagnant NS</u>			DAYS	0	3	5	7	9	<u>Stagnant NS</u>			DAYS	0	3	5	7	9
SMG1	Obs-Shoot		4.4	6.4	6.8	7.2	7.5		SMG1	Obs-Shoot		2.6	3.4	4.8	5.2	5.5	
	Obs-Root		0.4	0.6	1	1.8	2			Obs-Root		0.2	0.1	0.1	0.1	0.1	
	Sim-Shoot		5.3	7.2	7.3	7.9	8.3			Sim-Shoot		2.8	4.6	5.8	5.8	5.8	
	Sim-Root		0.4	1	1.5	2.1	2.7			Sim-Root		0.4	0.1	0	0	0	
	DAYS		0	3	5	7	9			DAYS		0	3	5	7	9	
FNBLS140	Obs-Shoot		2.4	2	2.9	2.8	2.7		FNBLS140	Obs-Shoot		1.2	1.3	1.8	2	2.5	
	Obs-Root		0.3	0.2	0.2	0.1	0.1			Obs-Root		0.1	0.2	0.3	0.4	0.3	
	Sim-Shoot		1.8	2.6	2.2	1.9	1.9			Sim-Shoot		1.3	1.5	1.6	1.7	1.8	
	Sim-Root		0.4	0.4	0.3	0.2	0.2			Sim-Root		0.7	0.6	0.6	0.6	0.6	
	DAYS		0	3	5	7	9			DAYS		0	3	5	7	9	
BRBRF9629	Obs-Shoot		2.2	3.5	4.8	5.5	6.2		BRBRF9629	Obs-Shoot		2.6	2.2	2.9	3.2	3	
	Obs-Root		0.2	0.3	0.3	0.4	0.4			Obs-Root		0.3	0.3	0.2	0.2	0.3	
	Sim-Shoot		3	4.7	6.8	7.6	6.8			Sim-Shoot		2.9	3.3	3.4	3.7	3.4	
	Sim-Root		0.4	0.8	0.8	0.7	0.7			Sim-Root		0.4	0.4	0.4	0.4	0.4	

## CURRICULUM VITAE

The author was born on March 15, 1959, in Phitsanuloke, Thailand. He is the eldest of the three children of Mr. Chuchip and Mrs. Prapasri Meechoui. He finished his secondary education from Sukhothai Wittayakhom School, Sukhothai, in 1975. He graduated with the secondary Honours degree of Bachelor of Science in Agriculture with a major in agronomy from Chiang Mai University, Chiang Mai, Thailand in 1979.

From October 1979 to May 1980, he worked as a research assistant at the Project Planning and Special Project Office, Department of Agricultural Extension, Ministry of Agriculture and Co-operation, Thailand. In 1980, he joined the staff of the Lampang Agricultural Research and Training Center and served also the instructor at Rajamangala Institute of Technology, Ministry of Education, Thailand.

In 1982, he entered Chiang Mai University to pursue his Master of Science degree in agronomy and graduated in 1985. From 1986-1996, he worked and joined the winter cereal crop research with the researchers from CIMMYT and from the Thai institutions. He also joined with the scientists from Boon Rawd Brewery Ltd. to research work on barley growth and productivity from 1988-1997.

In 1990, he received a grant from CIMMYT, Mexico for training in the course of "Experiment Station Management". In 1993, he joined the international workshop on "Physiology of Waterlogged Plants" which conducted at the Multiple Cropping Center, Chiangmai University. In 1995, he received a grant from Crawford Fund for participated in the international workshop on "Mechanisms of Tolerance of Crops to Waterlogging and Flooding" at the International Rice Research Institute (IRRI), Philippines.

In June, 1996, he entered Chiang Mai University to pursue the Doctor of Philosophy degree with a major in agronomy.

He is a member of the national winter cereal committee of Thailand, member of the national research council of Thailand.