

## CHAPTER IV RESULTS

### Demographic information of samples

From the result of AST and creatinine measurement, it was found that 12 clinically normal horses and 8 horses with OC, which had AST and creatinine level higher than reference value, were excluded from this research. Therefore, the value of chondroitin sulfate epitope (WF6 epitope) were analyzed from 50 clinically normal horses, 6 arthritis horses, 12 horses with OC and 24 horses with OA as shown in table 4.

The demographic data of samples were calculated including age, sex, breed and occupation of all subjects used. The means and standard deviation of age of each normal and abnormal horse groups were shown in table 5 and 6. Sex of all horses was shown in table 7. Breeds of subjects in this research consisted of Thai, Thoroughbred (TB), Standardbred (STB) and Mixed breed. The major horse breed was Thoroughbred (65.22%) following by Mixed (Thai+TB) breed (21.74%) as shown in table 8. Various occupations of horses were shown in table 9. Most of the occupation of these horses was racing (45.65%) following by riding horse (22.83%).

The number of affected joint in abnormal horses was shown in table 10. The cause of osteoarthritis was categorized as shown in table 11.

Table 4 Number of horses in each group.

Group	N	Percent (%)
Normal	50	54.35
Arthritis	6	6.52
OC	12	13.04
OA	24	26.09
Total	92	100

Table 5 Mean and standard deviation of age of normal horses.

Age (y)	N	Percent (%)	Mean $\pm$ SD
Lowest - 2	14	28	1.92 $\pm$ 0.14
3 - 5	21	42	3.76 $\pm$ 0.83
6 - 9	15	30	7.67 $\pm$ 1.05
Total	50	100	4.42 $\pm$ 2.41

Table 6 Mean and standard deviation of age of abnormal horses.

Age (y)	N	Percent (%)	Mean $\pm$ SD
Lowest - 2	0	0	0
3 - 5	28	66.67	4.02 $\pm$ 0.64
6 - 9	14	33.33	7.07 $\pm$ 1.14
Total	42	100	5.04 $\pm$ 1.67

Table 7 Sex of horse samples.

Sex	Normal		Abnormal		Total	
	N	Percent (%)	N	Percent (%)	N	Percent (%)
Male (Total)	49	98.00	25	59.52	74	80.43
Yearling-3y colt	23	46.94	0	0.00	23	25.00
Gelding	23	46.94	7	28.00	30	32.60
Stallion	3	6.12	18	72.00	21	22.82
Female	1	2.00	17	40.48	18	19.57
Total	50	100	42	100	92	100

Table 8 Breed of horse samples.

Breed	Normal		Abnormal		Total	
	N	Percent (%)	N	Percent (%)	N	Percent (%)
Thai breed	8	16.00	0	0.00	8	8.79
Thoroughbred (TB)	18	36.00	42	100	60	65.22
Standardbred (STB)	1	2.00	0	0.00	1	1.09
Mixed (Thai+TB)	20	40.00	0	0.00	20	21.74
Mixed (TB+STB)	3	6.00	0	0.00	3	3.26
Total	50	100	42	100	92	100

Table 9 Occupation of horse samples.

Occupation	Normal		Abnormal		Total	
	N	Percent (%)	N	Percent (%)	N	Percent (%)
No training	16	32.00	0	0.00	16	17.39
Training	13	26.00	0	0.00	13	14.13
Riding	19	38.00	2	4.76	21	22.83
Racing	2	4.00	40	95.24	42	45.65
Total	50	100	42	100	92	100

Table 10 Number of abnormal joints in abnormal horses.

Joint	N	Side of joint	
		Left	Right
Carpal joint	17	6	12
Fetlock joint	23	11	14
Pastern joint	2	1	1
Hock joint	1	1	0
Total	43	19	27

Table 11 Category of causes in osteoarthritic horses.

Cause	N	Percent
After intraarticular fracture	7	29.17
intraarticular chip fracture	4	16.67
intraarticular bone fracture	3	12.50
Associate with intraarticular fracture	3	12.50
Not know occurrence exactly	14	58.33
Total	24	100

### Optimization of competitive inhibition ELISA for WF6 assay

In determining WF6 epitope level in horse serum and synovial fluid, competitive inhibition ELISA technique was used by application of monoclonal antibody WF6, which recognized a native epitope in chondroitin sulfate chain. WF6 mAb was applied to detect this epitope in horse serum and synovial fluid using aggrecan (A1D1-fraction) as a standard competitor. The assay was developed by reagents that were shown in table 12. Then the absorbance standard curve for WF6 was plotted as shown in figure 15. The range of detectable concentration was 19.53-10000 ng/ml.

Table 12 The reagents of competitive inhibition ELISA for WF6 assay.

Reagent	WF6 assay
Coating antigen (concentration)	Shark PG (A1-fraction) (10 µg/ml)
Competitor (range)	Shark PG (A1D1-fraction) (19.53-10000 ng/ml)
Primary antibody (dilution)	WF6 mAb (1:200)
Secondary antibody (dilution)	Anti-IgM peroxidase (1:2000)

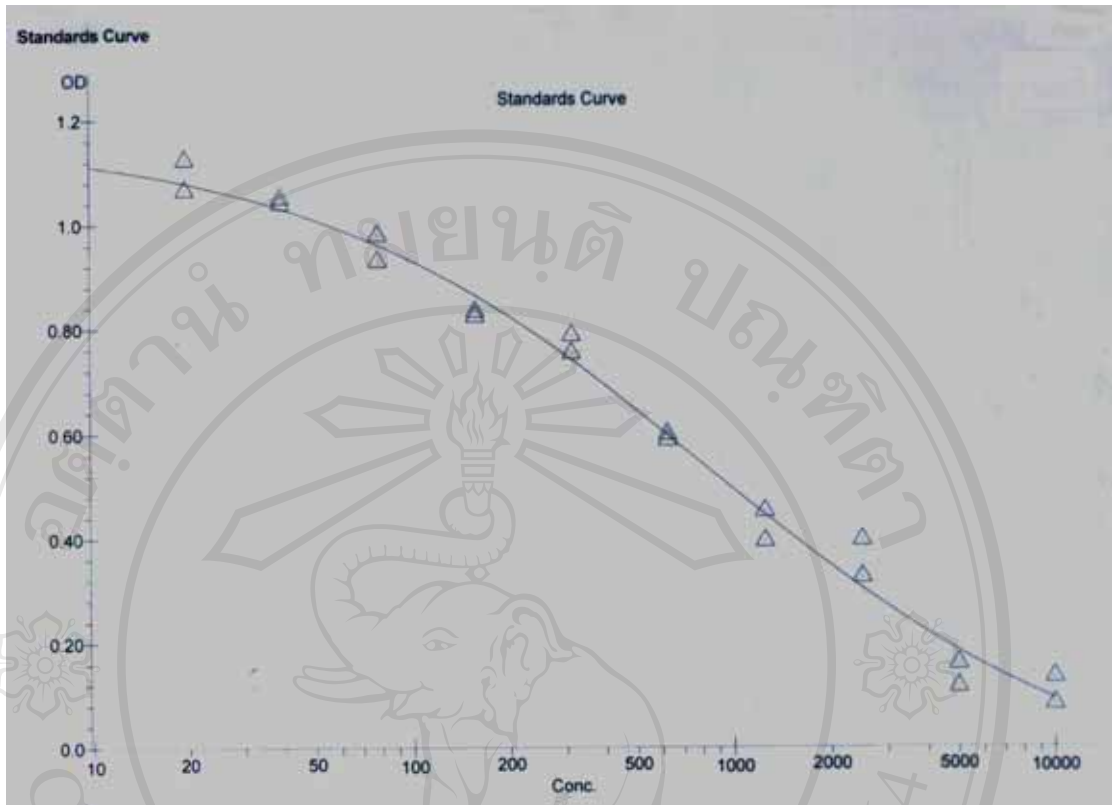

Figure 15 Typical WF6 standard curve by competitive inhibition ELISA.

ลิขสิทธิ์มหาวิทยาลัยเชียงใหม่  
Copyright © by Chiang Mai University  
All rights reserved

### Optimization of protein assay

Measurement of total protein (TP) concentration in serum and synovial fluid used microtitre plate technique that was described in protein assay method (chapter III). The absorbance standard curve for TP was plotted in figure 16. The range of detectable concentration was 15.625-1000 µg/ml.

It was found that undiluted synovial fluid samples could not be used directly due to the greater absorbance than the control level. Therefore, synovial fluid was diluted two fold in order to be within limit of the standard curve.

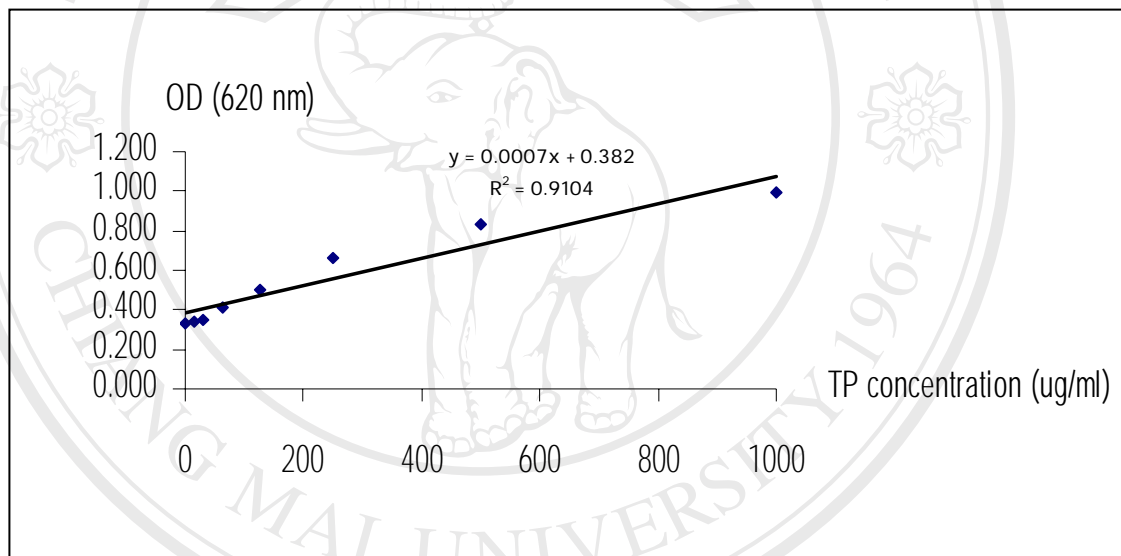

Figure 16 Typical TP standard curve by microtitre plate technique.



## Results of studies

The serum and synovial fluid WF6 epitope concentration of normal horses and horses with arthritis, osteochondral fracture and osteoarthritis were expressed as median and interquartile range (median, IQR) for all analyses.

### Study A: comparison the serum WF6 epitope between normal horses and horses with arthritis, osteochondral fracture or osteoarthritis

In this study, concentration of WF6 epitope in serum were determined and compared between normal horses and horses with arthritis, OC or OA. Also, the effects of other factors (age, breed, working status and diseased status of joint) to WF6 epitope level were evaluated.

The comparison of serum WF6 epitope concentration in normal and abnormal horses showed that abnormal horses had significantly lower median serum WF6 epitope concentration than clinically normal horses ( $p < 0.0001$ ) as shown in figure 17. Moreover, the result found that median concentration of serum WF6 epitope in horses with arthritis, OC or OA were significantly lower when compared with normal horses ( $p = 0.001$ ,  $p = 0.021$ ,  $p = 0.002$  respectively) as shown in figure 18.

For the comparison of serum WF6 epitope concentration in 3 categories depending on age of clinically normal horses, there was no significant difference of WF6 epitope level in horse aged less than 2 to 9 years old ( $p = 0.122$ ) as shown in figure 19. Also, there was no significant difference of this epitope level at any breed groups ( $p = 0.158$ ) as in figure 20. However, it was found that working horses had significantly higher WF6 epitope concentration than no training horses ( $p = 0.008$ ) as in figure 21.

From multivariable analysis, the result showed that factors; diseased status of joint and working status had significant effects on WF6 epitope level in serum, there was significant correlation between diseased status of joint or working status and serum WF6 epitope concentration ( $p < 0.0001$  and  $p = 0.022$ ). Diseased status of joint was negatively correlated, and working status was positively correlated to the WF6 epitope concentration in serum ( $\beta = -0.545$  and  $\beta = 0.236$ ).

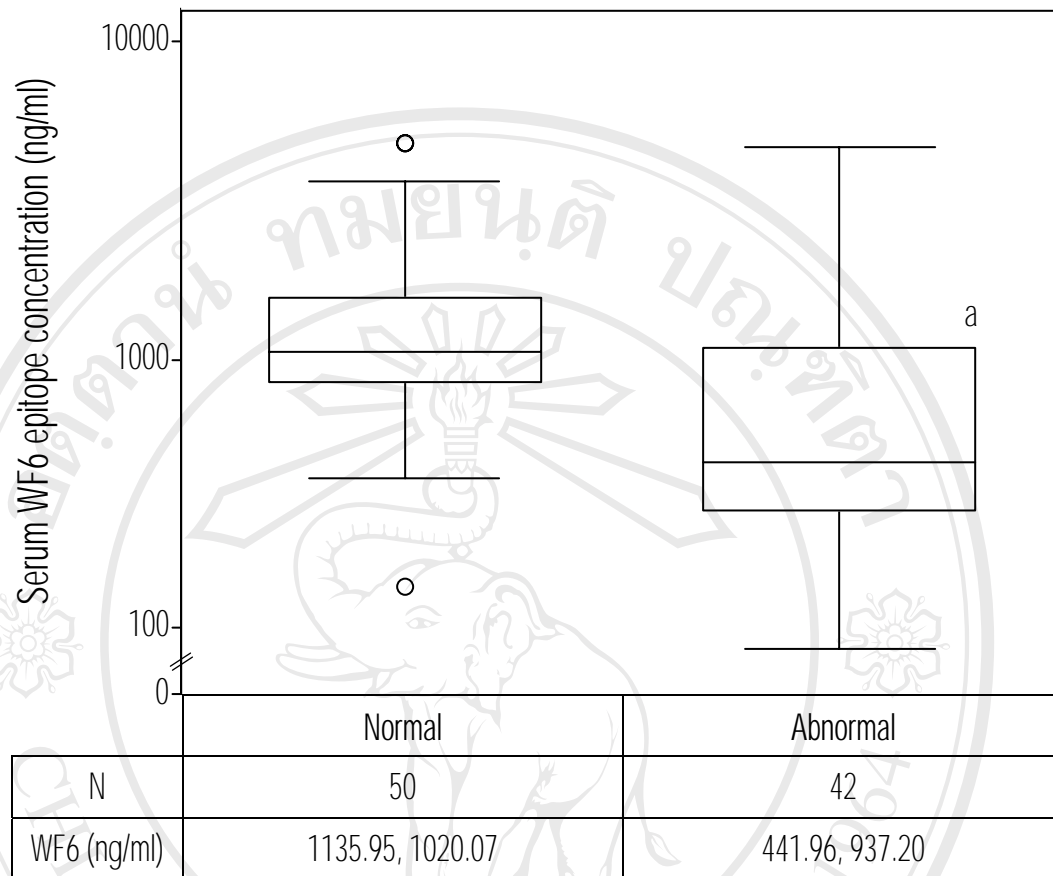

a = significant difference ( $p < 0.0001$ ) when compared with normal

Figure 17 Comparison of serum WF6 epitope concentration between normal and abnormal horses. Lines in the boxes show median value. The lower and the upper edge of the boxes show value at percentile 25 and 75. And between the lines outside the boxes show the maximum and minimum values. Circles show outlier values and stars show the extreme values. N = number of sample and WF6 = median, interquartile range of serum WF6 epitope concentration (ng/ml).

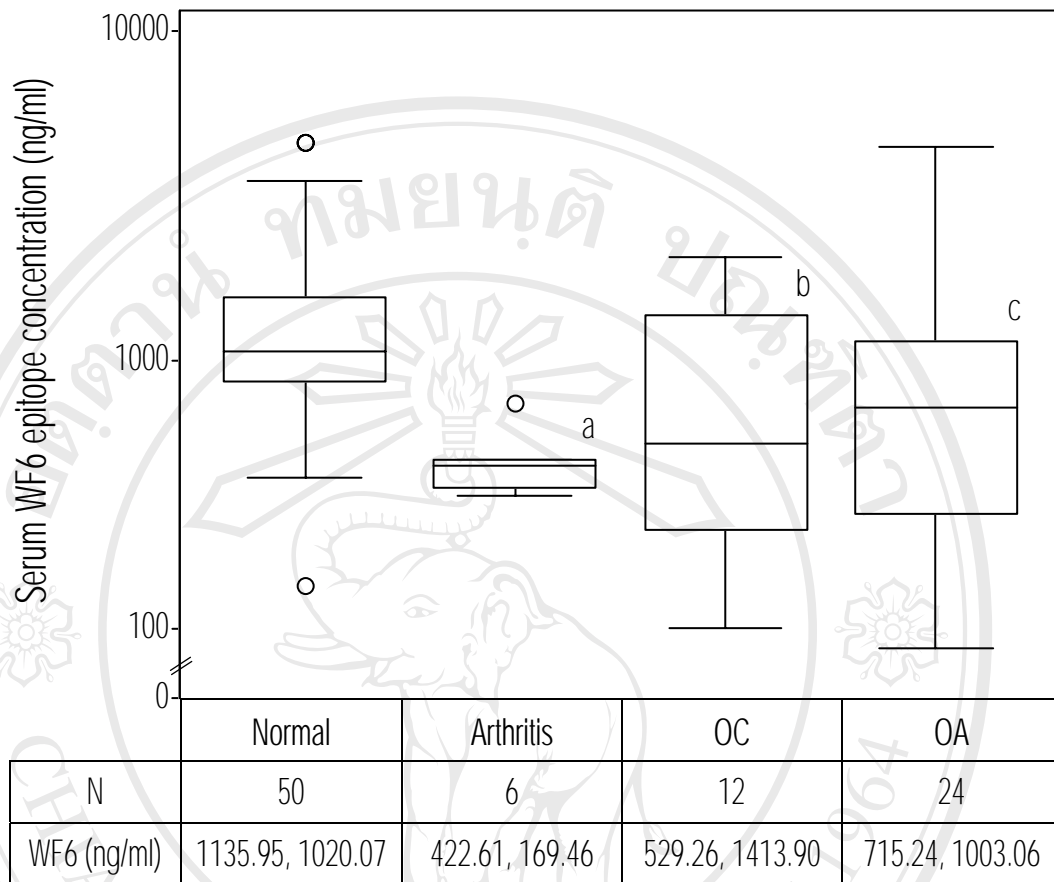

a, b, c = significant difference ( $p=0.001$ ,  $p=0.021$ ,  $p=0.002$ ) when compared with normal, respectively.

Figure 18 Comparison the serum WF6 epitope between normal horses and horses with arthristis, osteochondral fracture (OC) or osteoarthritis (OA). Lines in the boxes show median value. The lower and the upper edge of the boxes show value at percentile 25 and 75. And between the lines outside the boxes show the maximum and minimum values. Circles show outlier values and stars show the extreme values. N = number of sample and WF6 = median, interquartile range of serum WF6 epitope concentration (ng/ml).

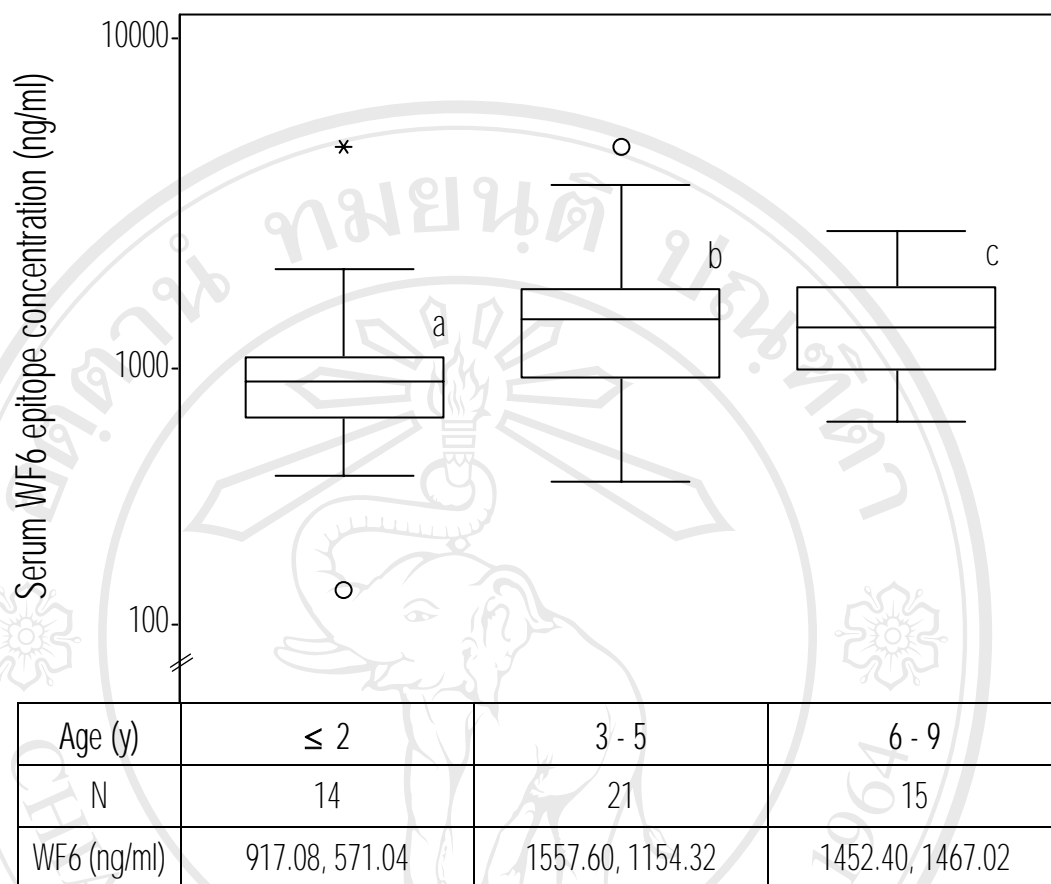

a, b, c = no significant difference ( $p=0.122$ )

Figure 19 Comparison of serum WF6 epitope among normal horses by age groups. Lines in the boxes show median value. The lower and the upper edge of the boxes show value at percentile 25 and 75. And between the lines outside the boxes show the maximum and minimum values. Circles show outlier values and stars show the extreme values. N = number of sample and WF6 = median, interquartile range of serum WF6 epitope concentration (ng/ml).

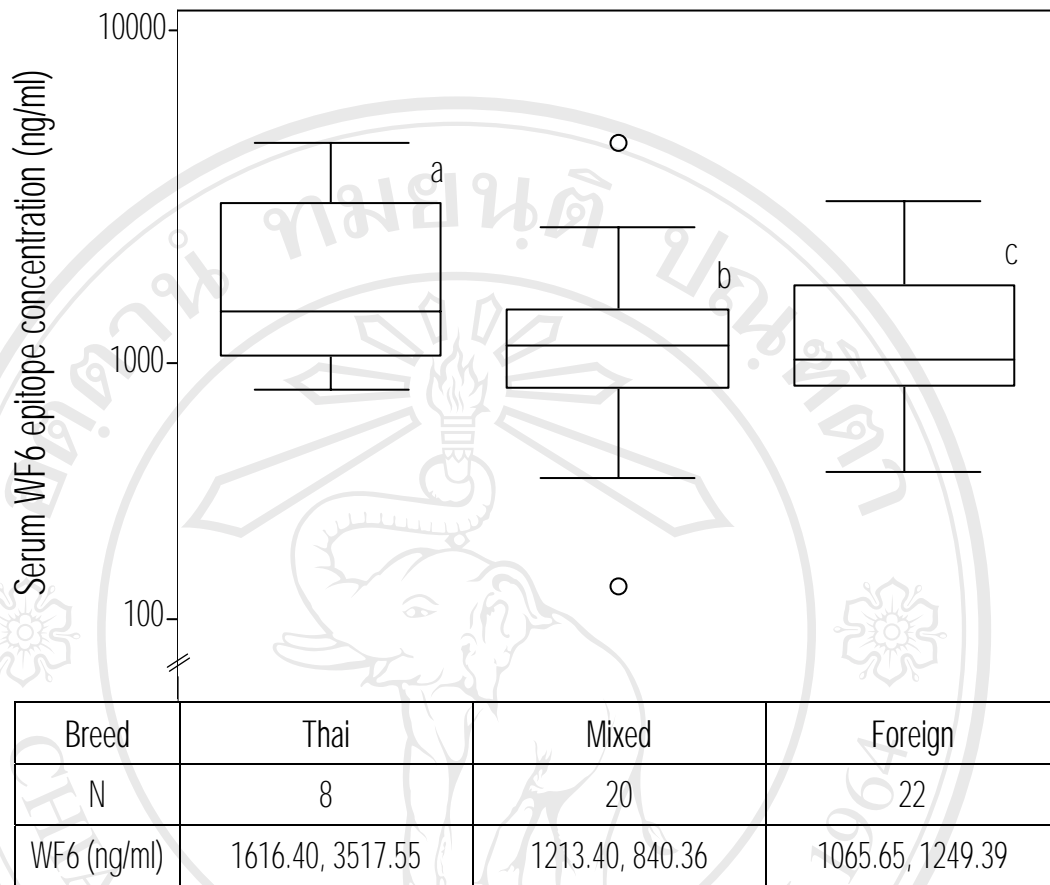

a, b, c = no significant difference ( $p=0.158$ )

Figure 20 Comparison of serum WF6 epitope among normal horses by breed. Lines in the boxes show median value. The lower and the upper edge of the boxes show value at percentile 25 and 75. And between the lines outside the boxes show the maximum and minimum values. Circles show outlier values and stars show the extreme values. N = number of sample and WF6 = median, interquartile range of serum WF6 epitope concentration (ng/ml).

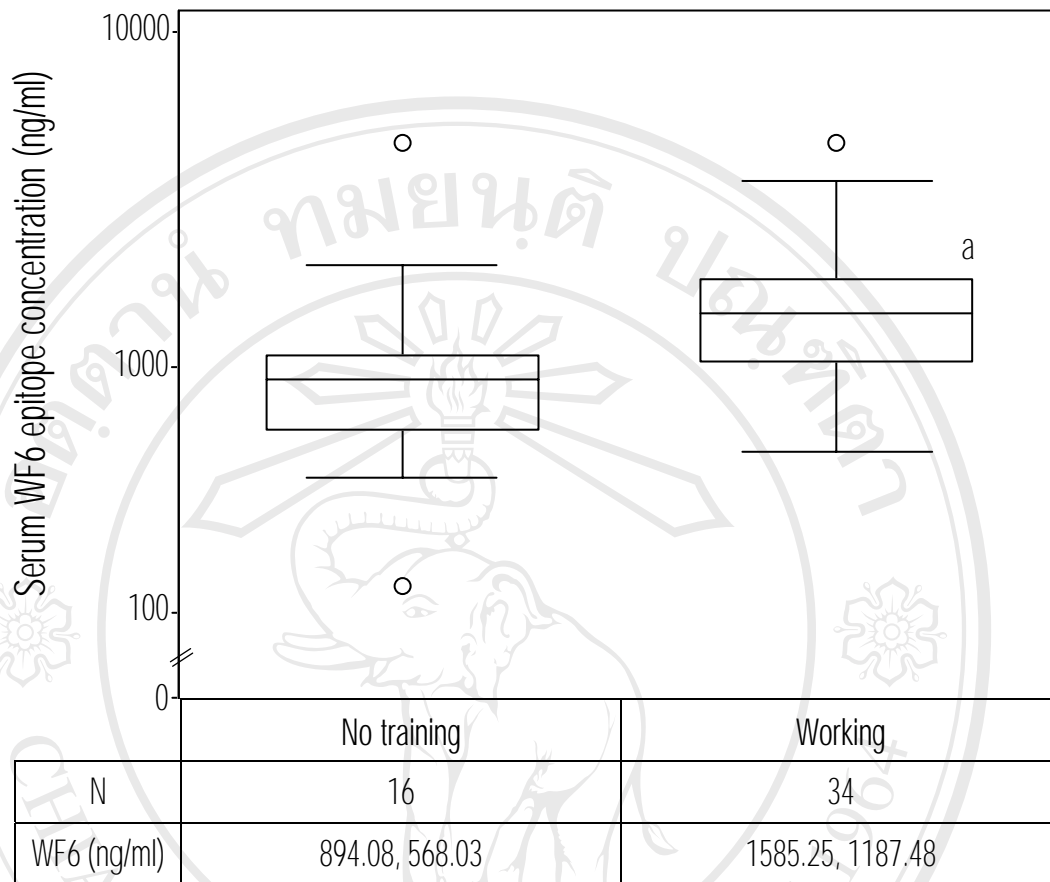

a = significant difference ( $p=0.008$ ) when compared with no training

Figure 21 Comparison of serum WF6 epitope concentration in normal horses between no training and working horses. Lines in the boxes show median value. The lower and the upper edge of the boxes show value at percentile 25 and 75. And between the lines outside the boxes show the maximum and minimum values. Circles show outlier values and stars show the extreme values. N = number of sample and WF6 = median, interquartile range of serum WF6 epitope concentration (ng/ml).

For total protein (TP) determination in serum, the comparison of serum total protein concentration in normal and abnormal horses showed that there was no significant difference of serum TP concentration in normal and abnormal horses ( $p=0.204$ ) as shown in figure 22. Also, the result found that there was no significant difference of serum TP concentration in all horse groups ( $p=0.159$ ) as shown in figure 23.

The comparison of WF6 epitope/TP concentration in serum between normal and abnormal horses showed that abnormal horses had significantly lower serum WF6 epitope/TP concentration than normal horses ( $p<0.0001$ ) as shown in figure 24. Moreover, the result found that the concentration of serum WF6 epitope/TP in horses with arthritis, OC or OA were significantly lower when compared with normal horses ( $p<0.0001$ ) as shown in figure 25.

From the correlation between WF6 epitope (ng/ml) and WF6 epitope/TP (ng/mg) concentrations in serum of normal, abnormal, arthritic, OC and OA horses, the results showed that there were significant positive correlations between WF6 epitope and WF6 epitope/TP concentrations in serum of all horse groups, excepted in arthritic group as shown in table 13 and figure 26-30.

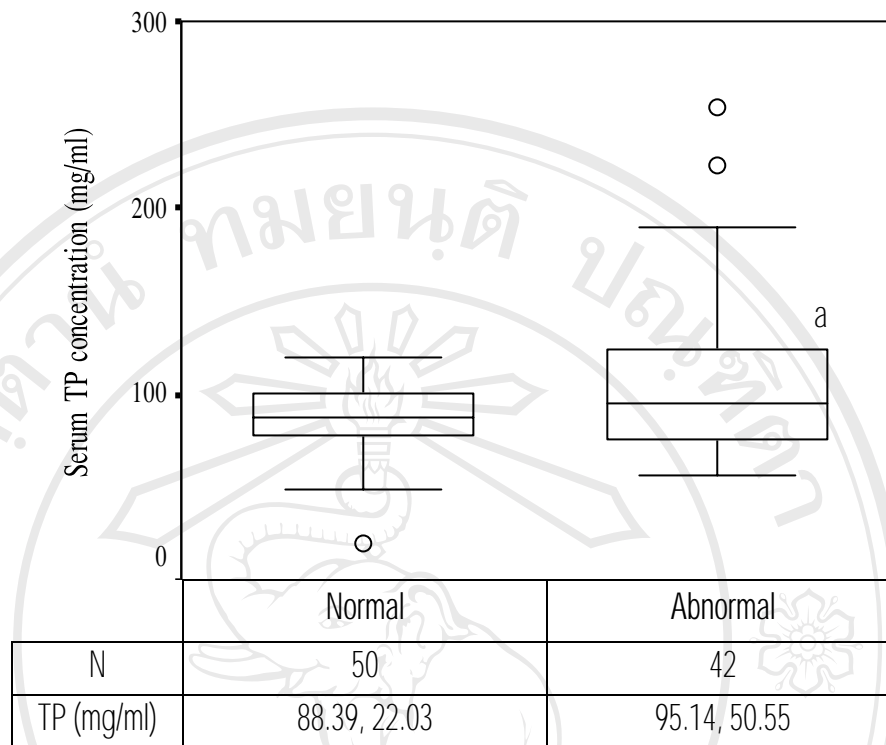

a = no significant difference ( $p=0.204$ ) when compared with normal

Figure 22 Comparison of serum total protein concentration in normal and abnormal horses. Lines in the boxes show median value. The lower and the upper edge of the boxes show value at percentile 25 and 75. And between the lines outside the boxes show the maximum and minimum values. Circles show outlier values and stars show the extreme values. N = number of sample and TP = median, interquartile range of serum total protein concentration (mg/ml).



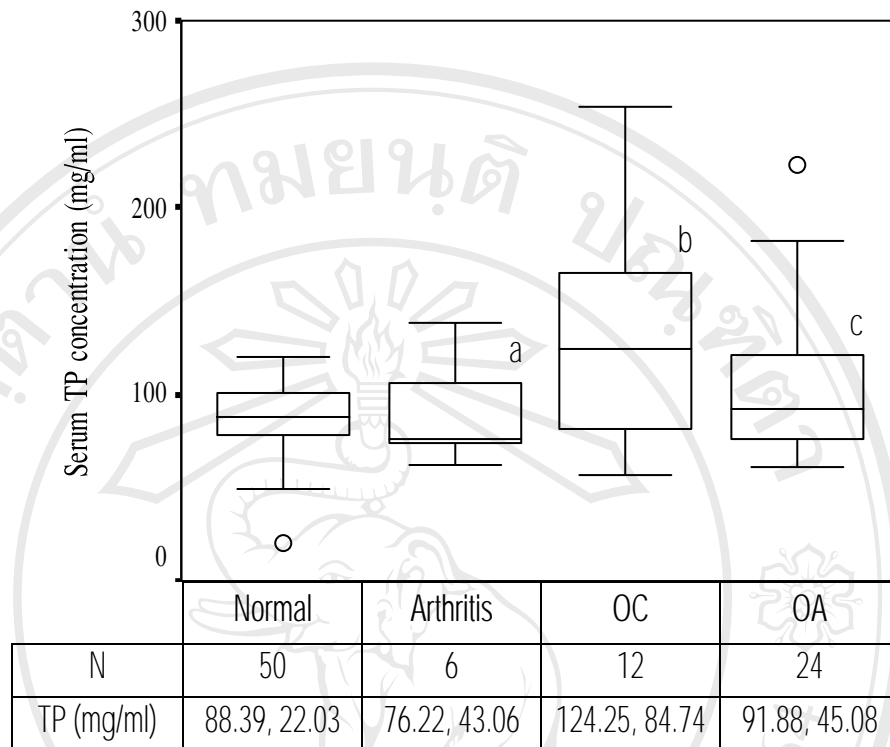

a, b, c = no significant difference ( $p=0.159$ ) when compared with normal

Figure 23 Comparison of serum total protein concentration between normal horses and horses with arthristis, osteochondral fracture (OC) or osteoarthritis (OA). Lines in the boxes show median value. The lower and the upper edge of the boxes show value at percentile 25 and 75. And between the lines outside the boxes show the maximum and minimum values. Circles show outlier values and stars show the extreme values. N = number of sample and TP = median, interquartile range of serum total protein concentration (mg/ml).

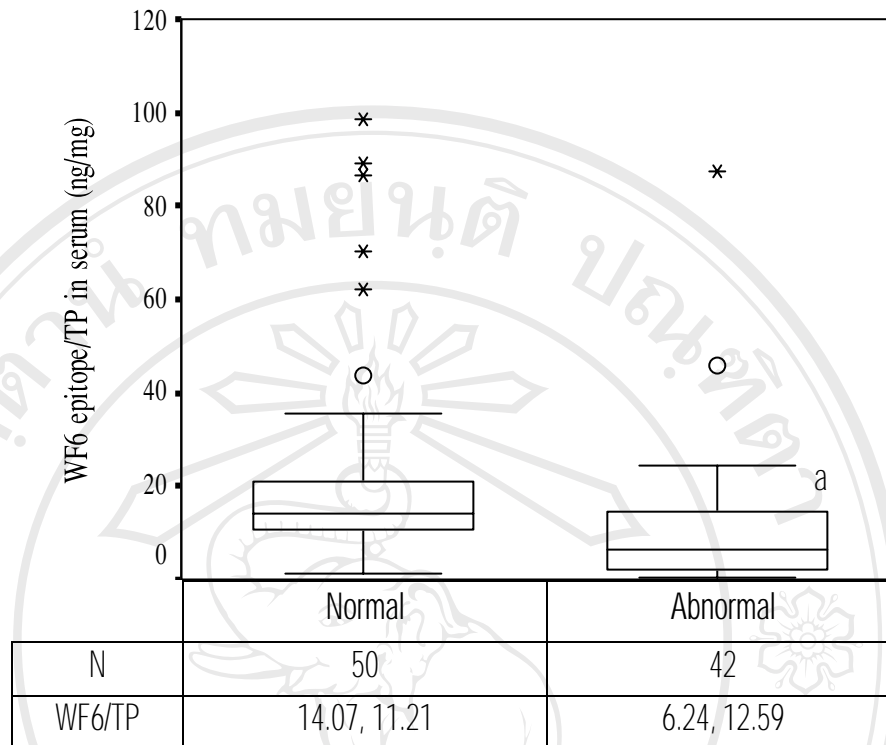

a = significant difference ( $p < 0.0001$ ) when compared with normal

Figure 24 Comparison of serum WF6 epitope/TP concentration in normal and abnormal horses. Lines in the boxes show median value. The lower and the upper edge of the boxes show value at percentile 25 and 75. And between the lines outside the boxes show the maximum and minimum values. Circles show outlier values and stars show the extreme values. N = number of sample and WF6/TP = median, interquartile range of serum WF6 epitope/TP concentration (ng/mg).

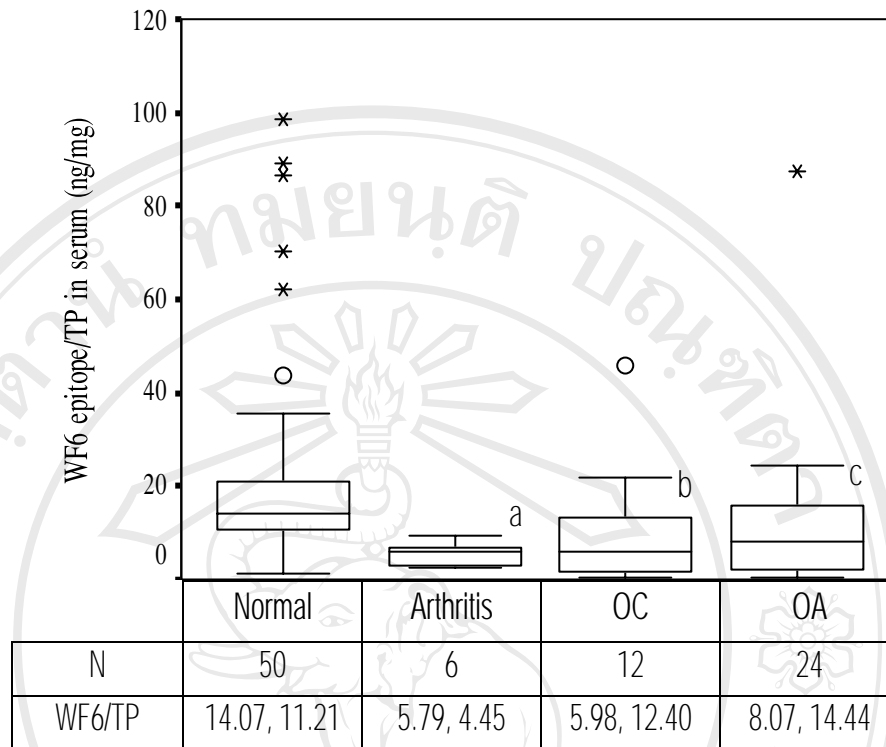

a, b, c = significant difference ( $p < 0.0001$ ) when compared with normal

Figure 25 Comparison of serum WF6 epitope/TP concentration between normal horses and horses with arthristis, osteochondral fracture (OC) or osteoarthritis (OA). Lines in the boxes show median value. The lower and the upper edge of the boxes show value at percentile 25 and 75. And between the lines outside the boxes show the maximum and minimum values. Circles show outlier values and stars show the extreme values. N = number of sample and WF6/TP = median, interquartile range of serum WF6 epitope/TP concentration (ng/mg).

Table 13 Correlation between concentrations of WF6 epitope and WF6 epitope/TP in serum of normal, abnormal, arthritic, OC and OA horses

Group	r	Sig. (2-tailed)
Normal	0.925	0.000
Abnormal	0.959	0.001
Arthritis	0.714	0.111
OC	0.892	0.000
OA	0.953	0.000

r = standardized regression coefficient.

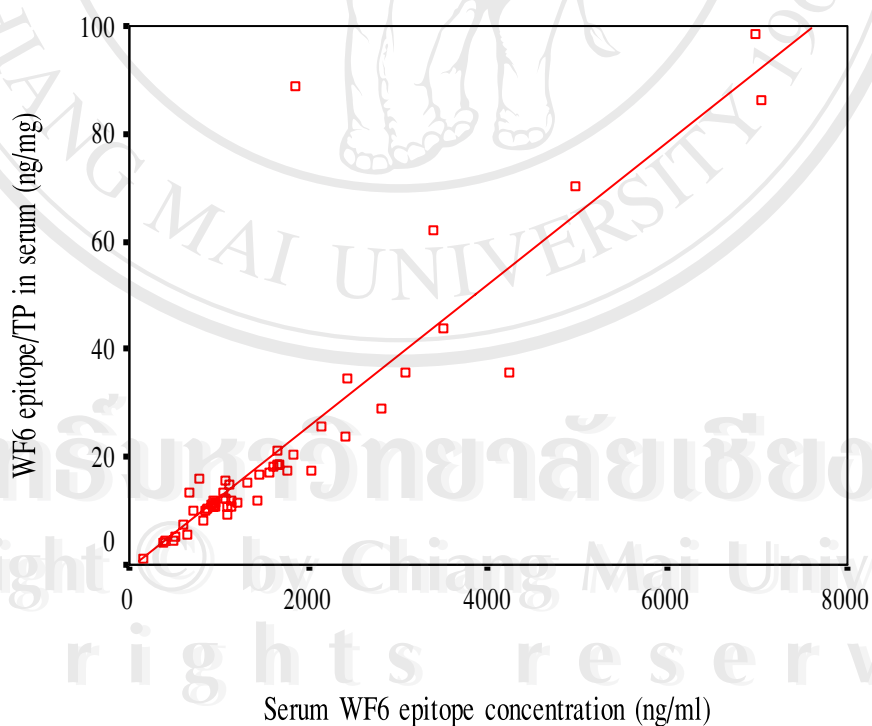

Figure 26 Correlation between concentrations of WF6 epitope and WF6 epitope/TP in serum of normal horses.

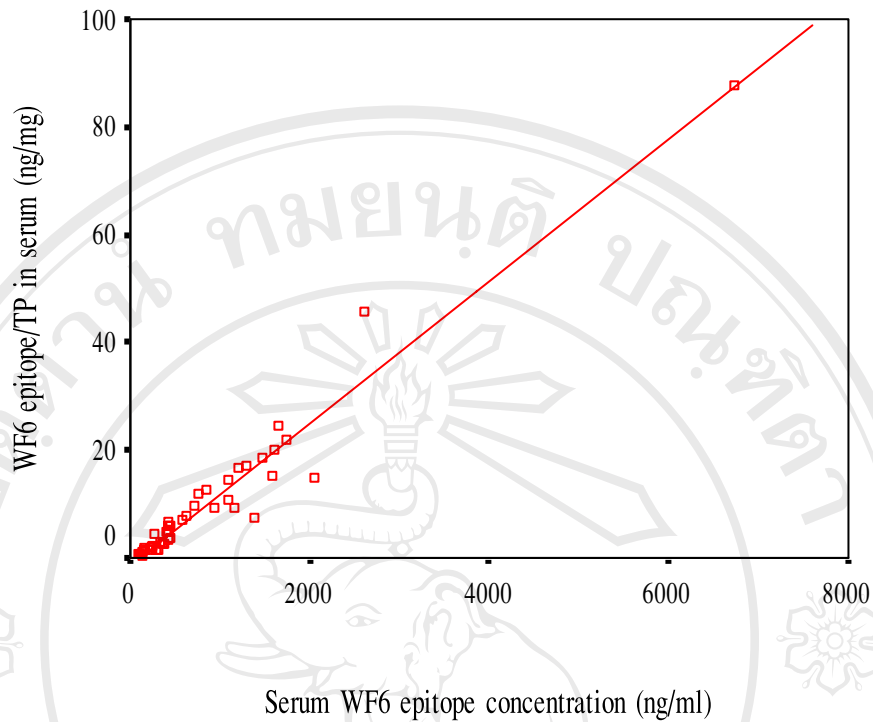

Figure 27 Correlation between concentrations of WF6 epitope and WF6 epitope/TP in serum of abnormal horses.

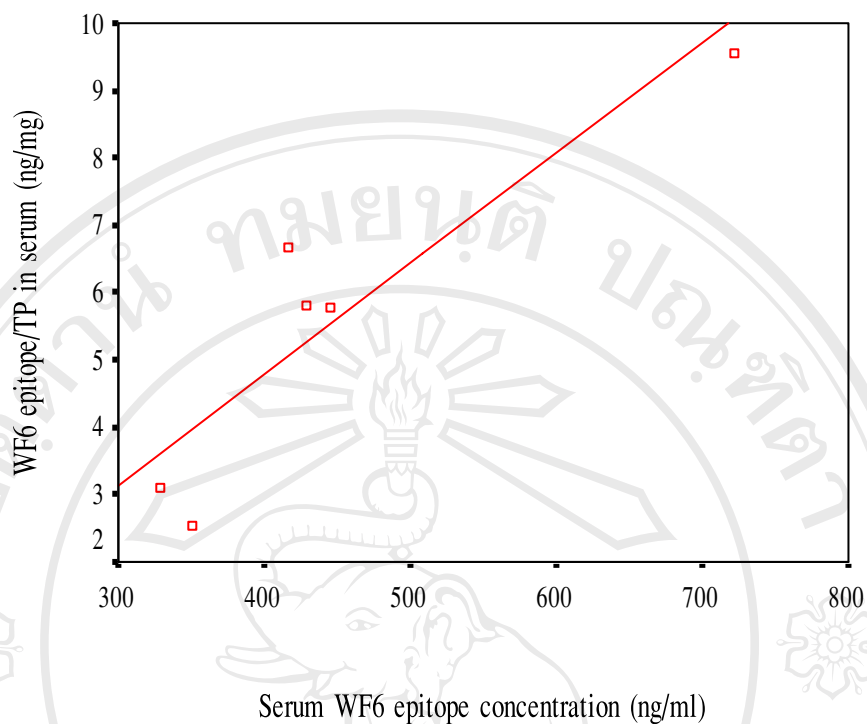

Figure 28 Correlation between concentrations of WF6 epitope and WF6 epitope/TP in serum of arthritic horses.

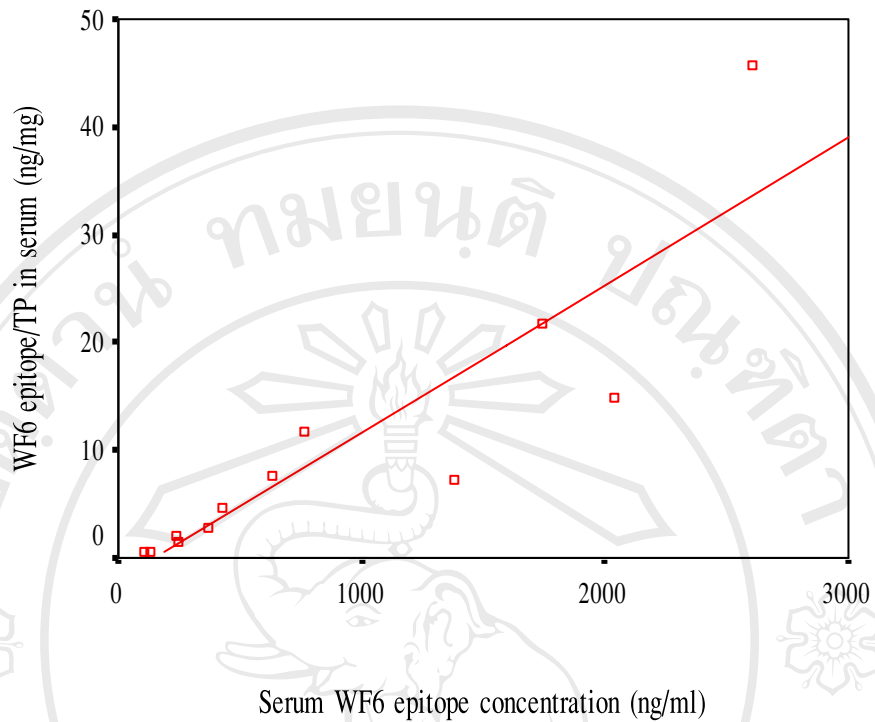

Figure 29 Correlation between concentrations of WF6 epitope and WF6 epitope/TP in serum of OC horses.

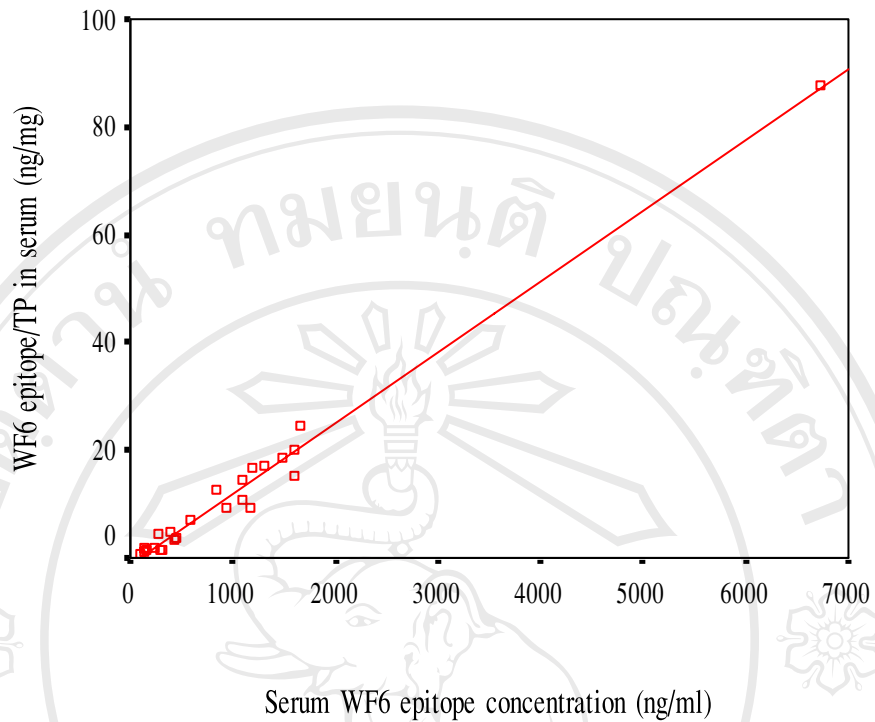

Figure 30 Correlation between concentrations of WF6 epitope and WF6 epitope/TP in serum of OA horses.



Study B: comparison the serum WF6 epitope in horse with osteochondral fracture between before and after treatment by arthroscopic surgery

This study compared white blood cell count (WBC) and concentration of serum WF6 epitope in 1 horse with OC between before and after arthroscopic surgery. Two horses were lost during research monitoring because they died from *Herpes* virus vaccination.

From WBC count, the OC horse had WBC count more than normal value before treatment (week 0). After arthroscopic surgery, it was found that WBC count had decreasing in week 4 and 8 when compared with week 0. However, WBC value increased again after treatment at week 12. In WF6 epitope determination, the result found that the serum WF6 epitope concentration gradually increased after treatment from week 4, 8 to 12 as shown in figure 31.

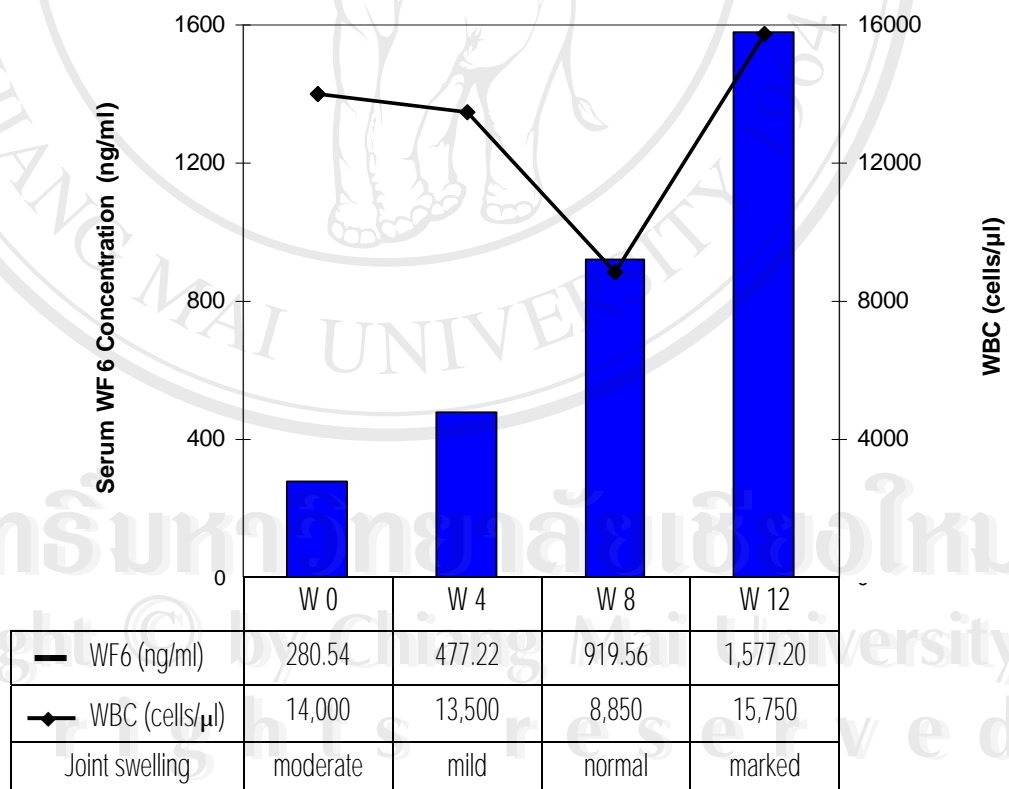

Figure 31 Diagram shows WF6 epitope concentration in serum and WBC count in horse with osteochondral fracture between before and after arthroscopic surgery.

Study C: comparison the WF6 epitope in synovial fluid between abnormal and contralateral normal joints of horses with osteochondral fracture or osteoarthritis.

This study compared the WF6 epitope/total protein (TP) concentration (ng/mg) in synovial fluid between abnormal and contralateral normal carpal joints of 2 horses with OC and 1 OA horse.

The first OC horse (OC1), it was found that the WF6 epitope/TP concentration in abnormal joint (OC joint) was lower than in the contralateral joint. Determination of this concentration in OC2 showed the contrast result with OC1. For OA horse, the result found that the concentration of WF6 epitope/TP was higher in abnormal joint (OA joint) when compared to the contralateral joint as shown in figure 32.

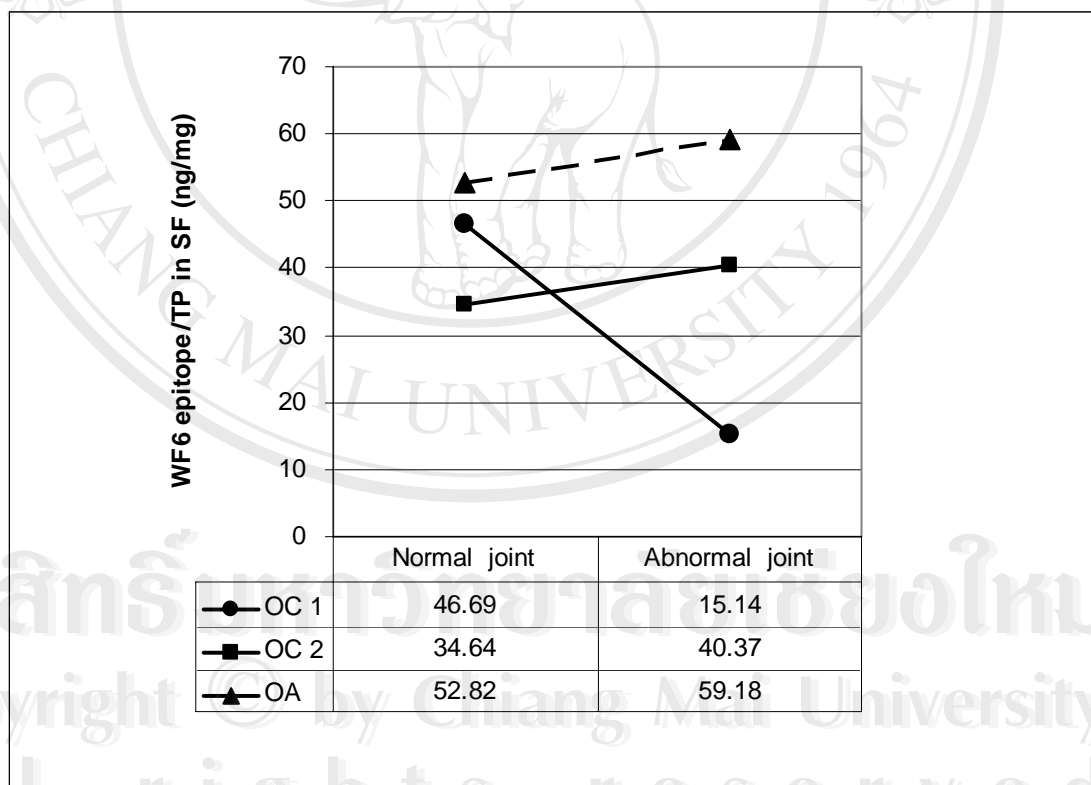

Figure 32 Comparison of WF6 epitope/TP concentration in synovial fluid between abnormal and contralateral normal joints of OC and OA horses. Number in the table show the concentration of WF6 epitope/TP in synovial fluid.